

XIV

421^b

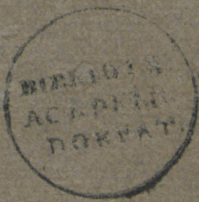

ESTICA

B. 915

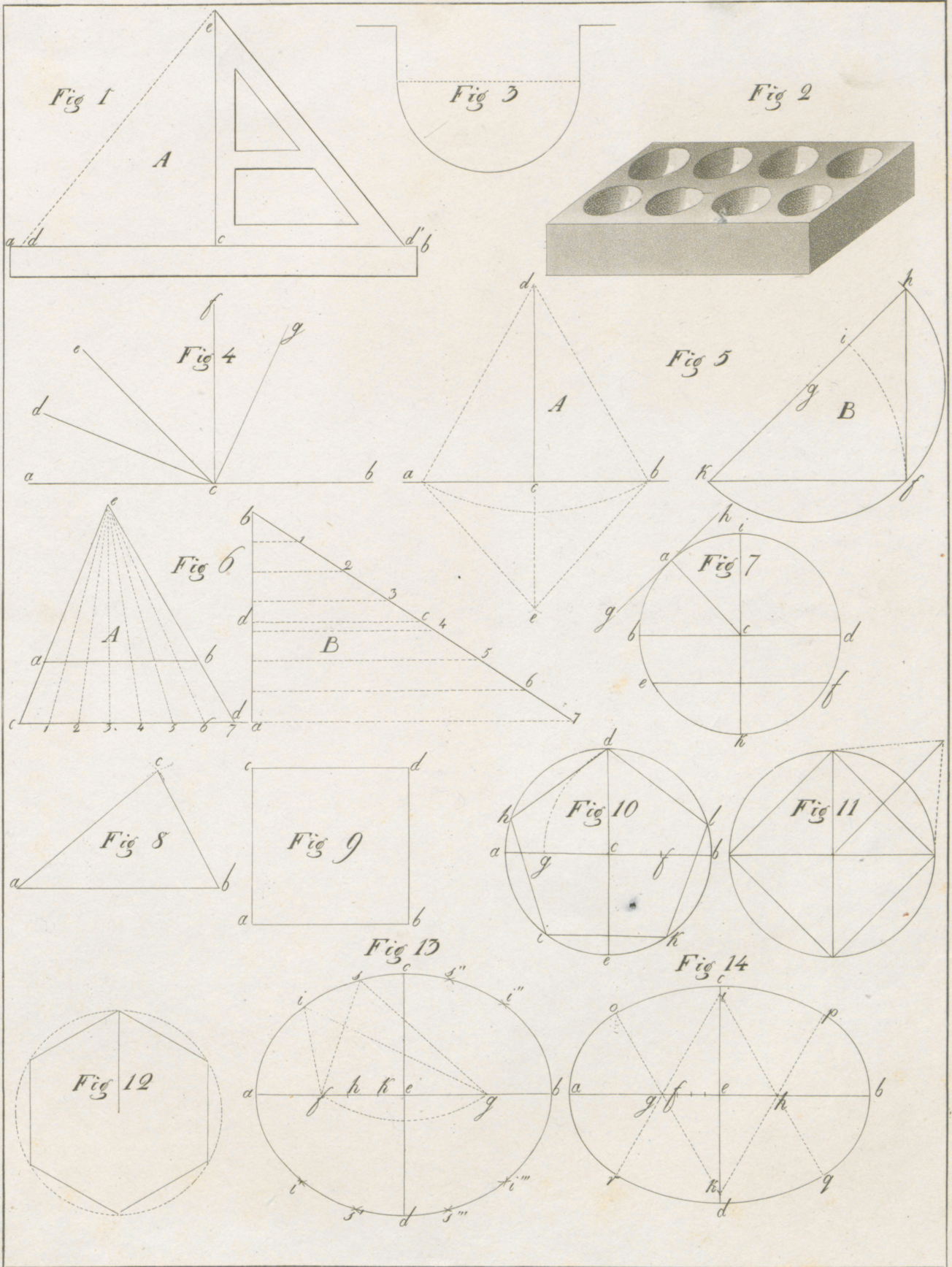

Fig 15

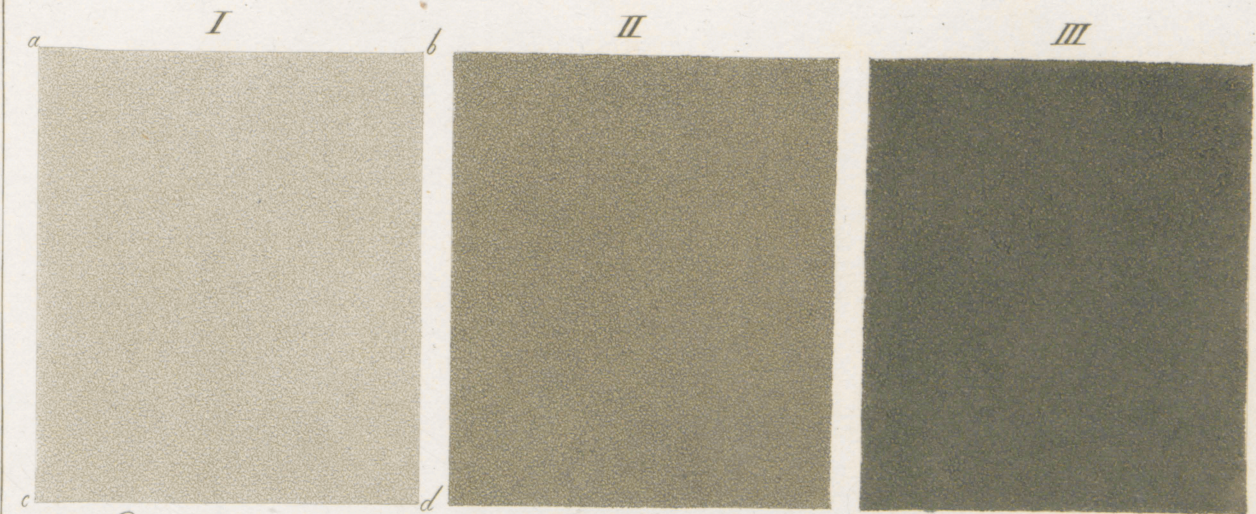
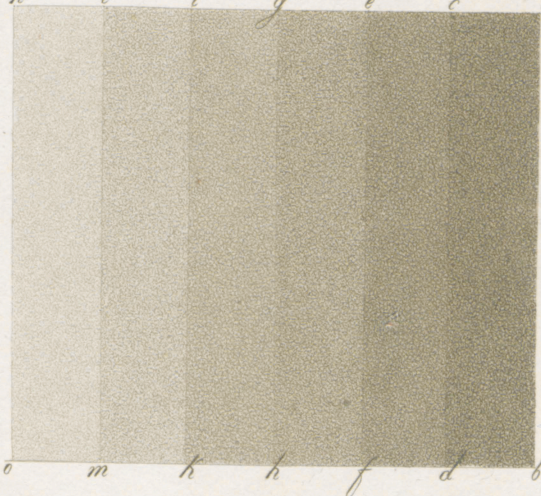

Fig 16



A

Fig 17



B

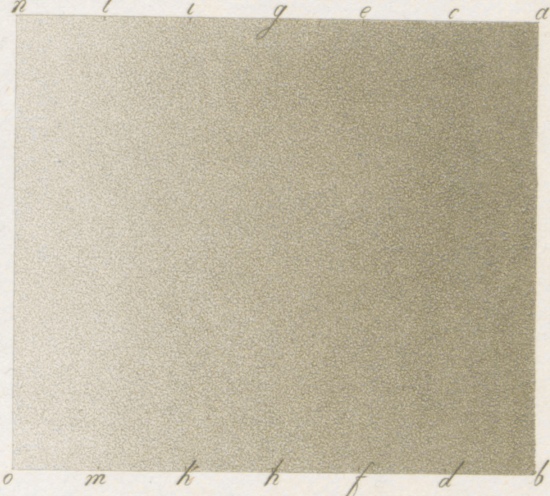

Fig 18

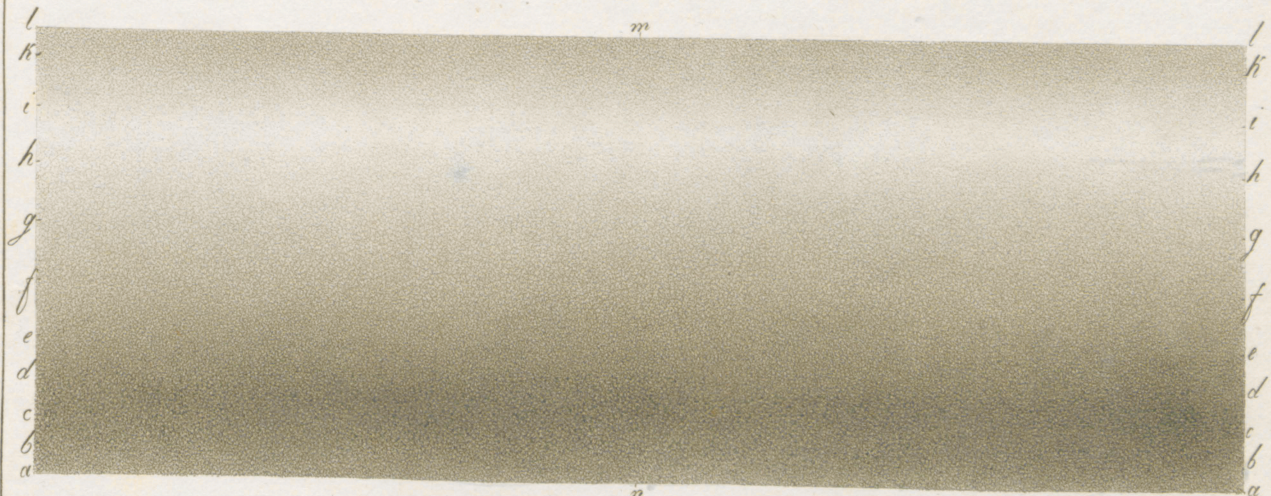

Fig 19

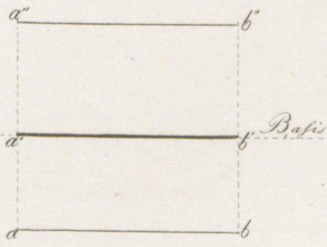

Fig 20

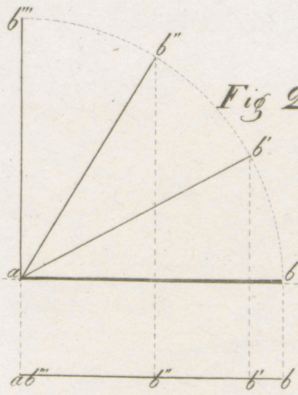

Fig 21

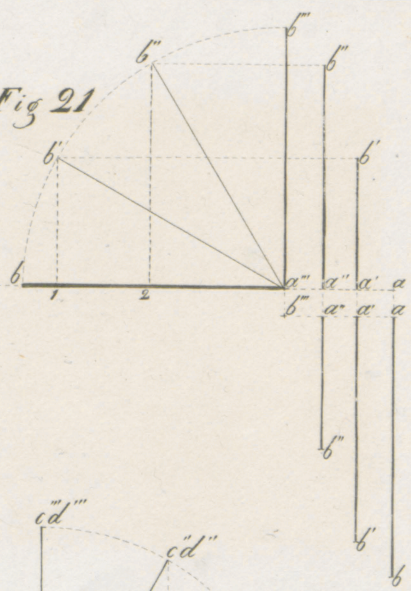

Fig 22

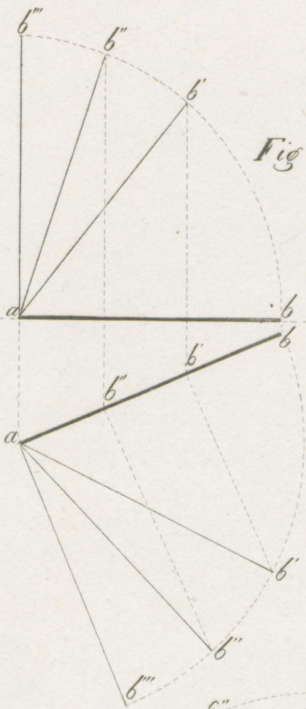

Fig 23

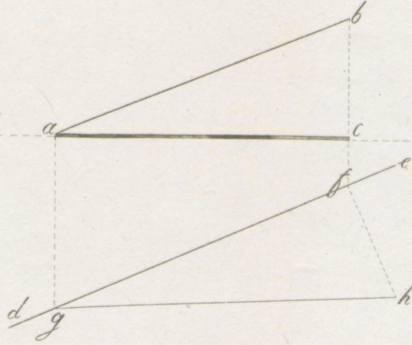

Fig 24

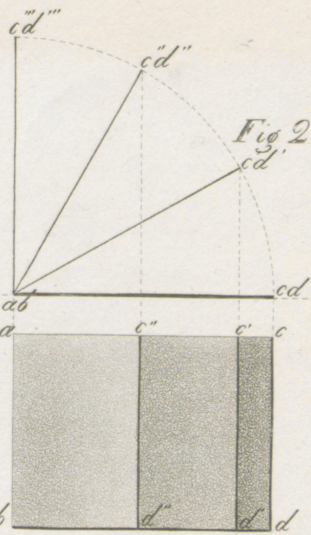

Fig 25

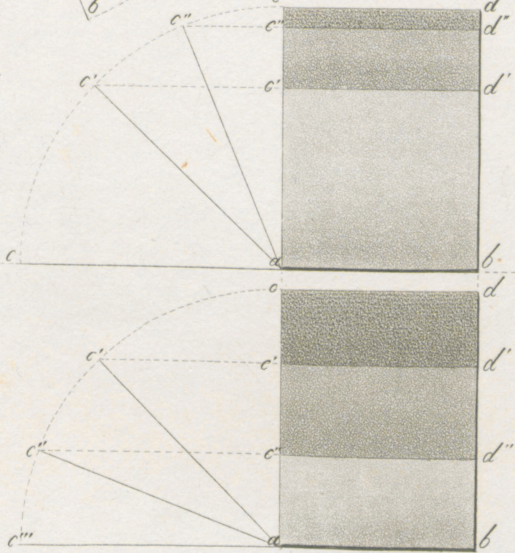

Fig 26

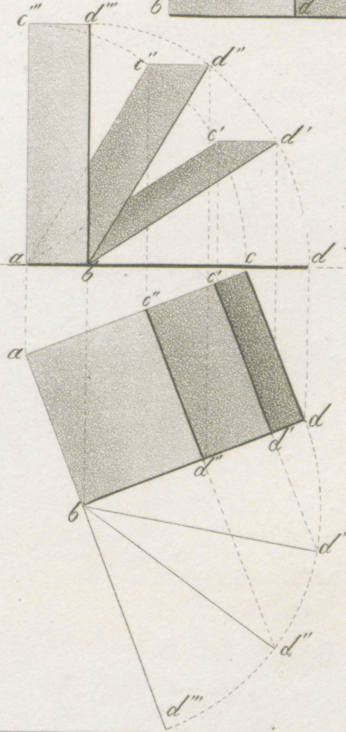

Fig 27

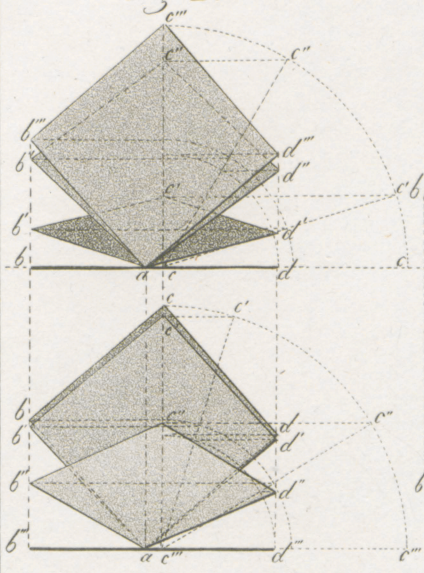

Fig 28

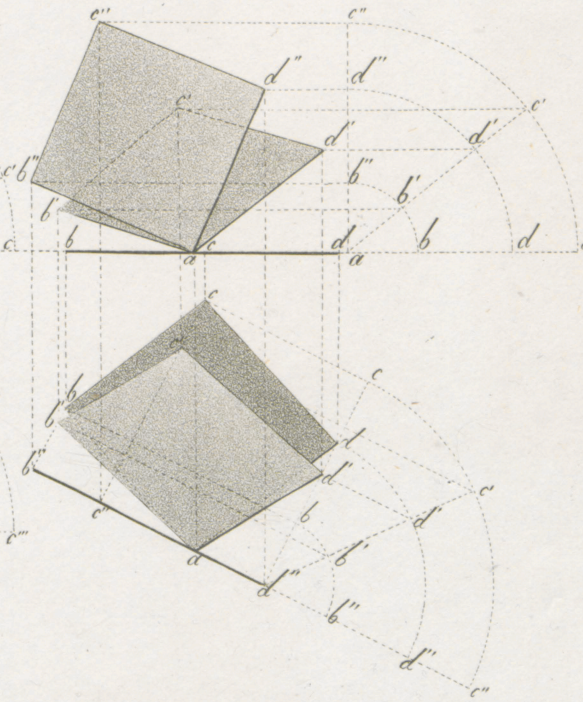

Fig 29

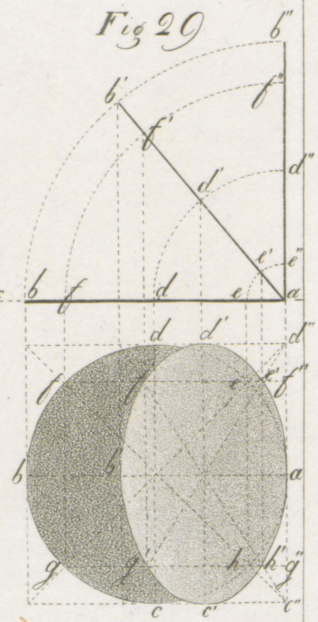

Fig 30

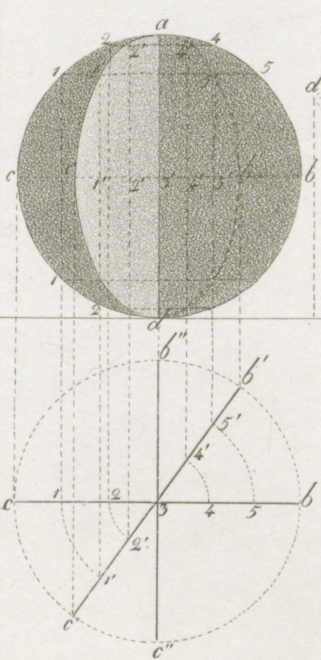

Fig 31

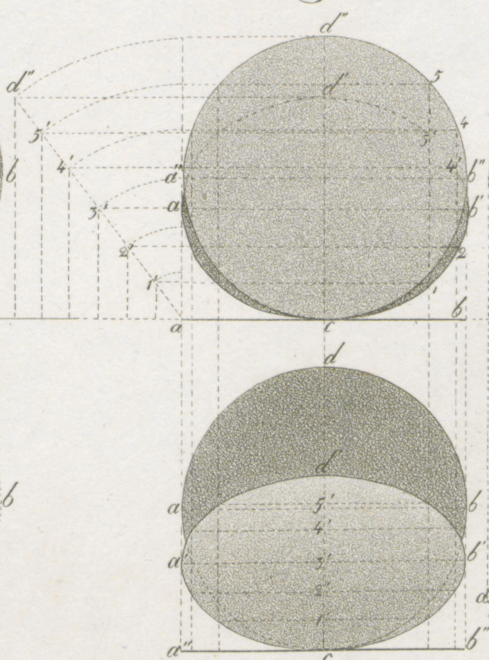
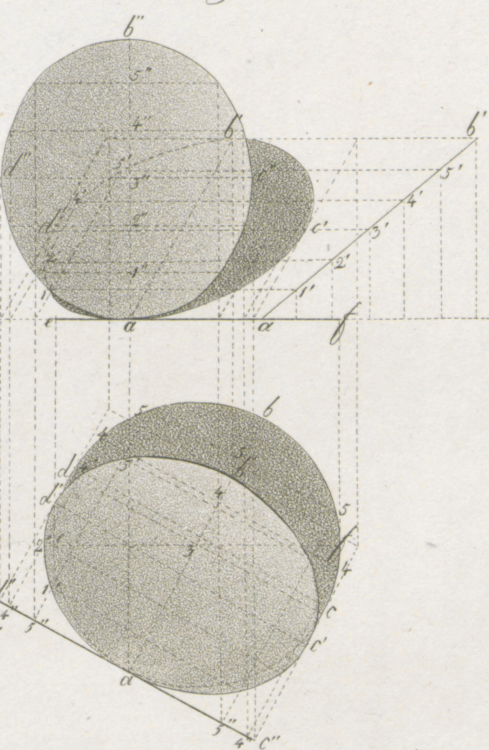

Fig 32



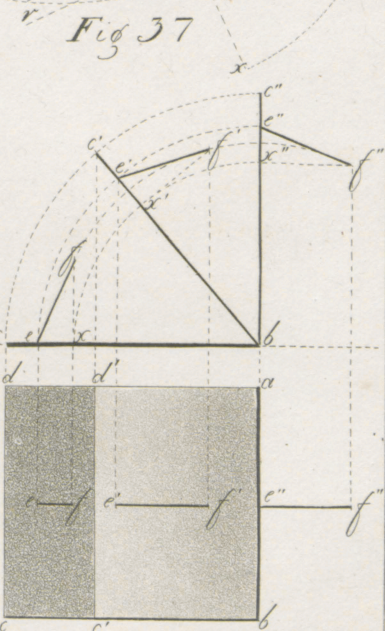
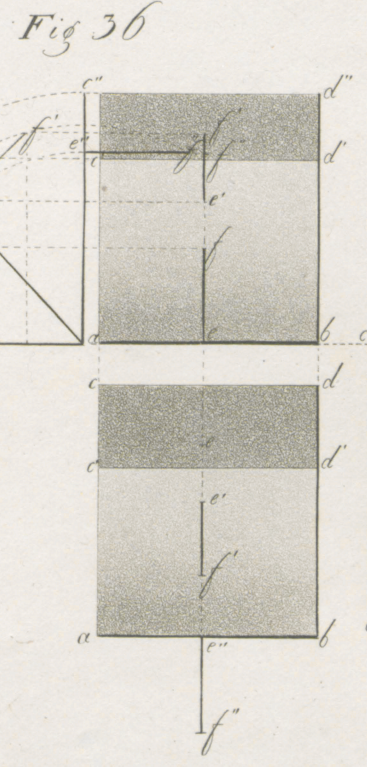
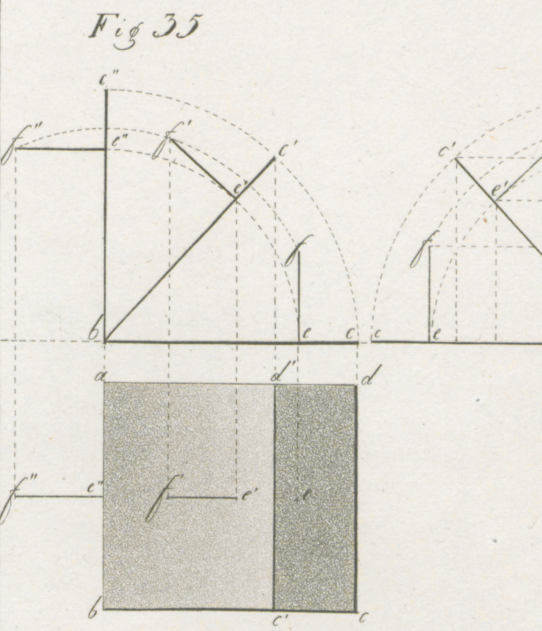
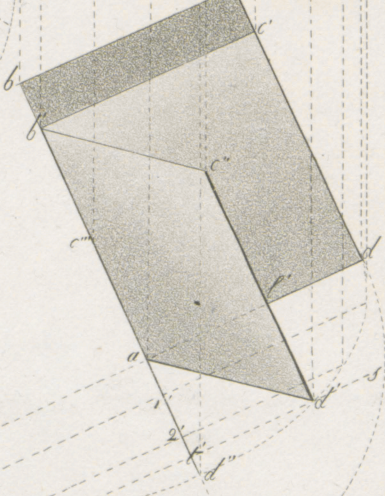
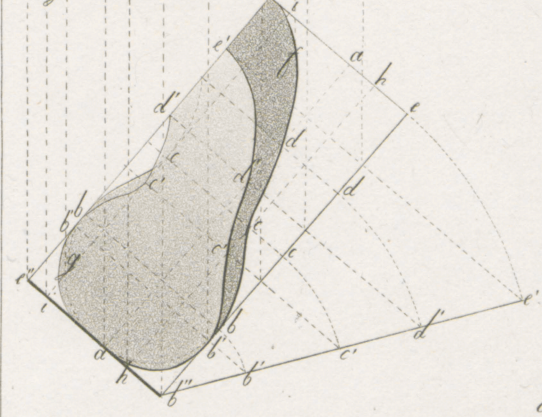
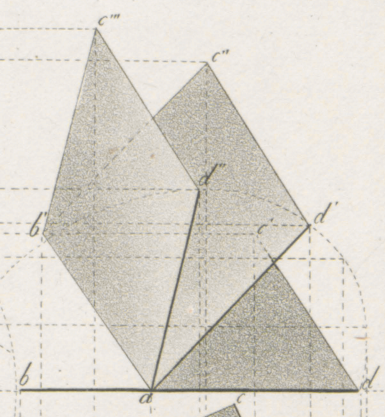
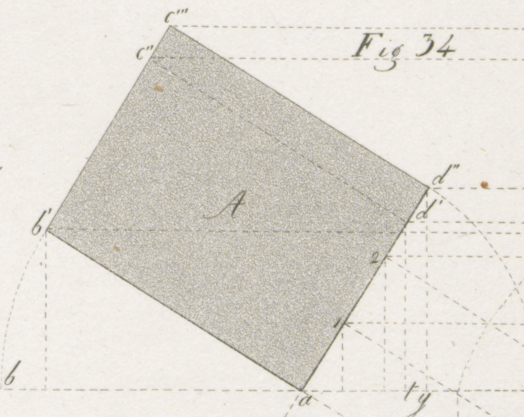
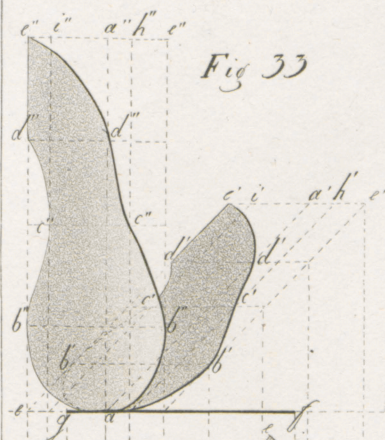

Fig 38

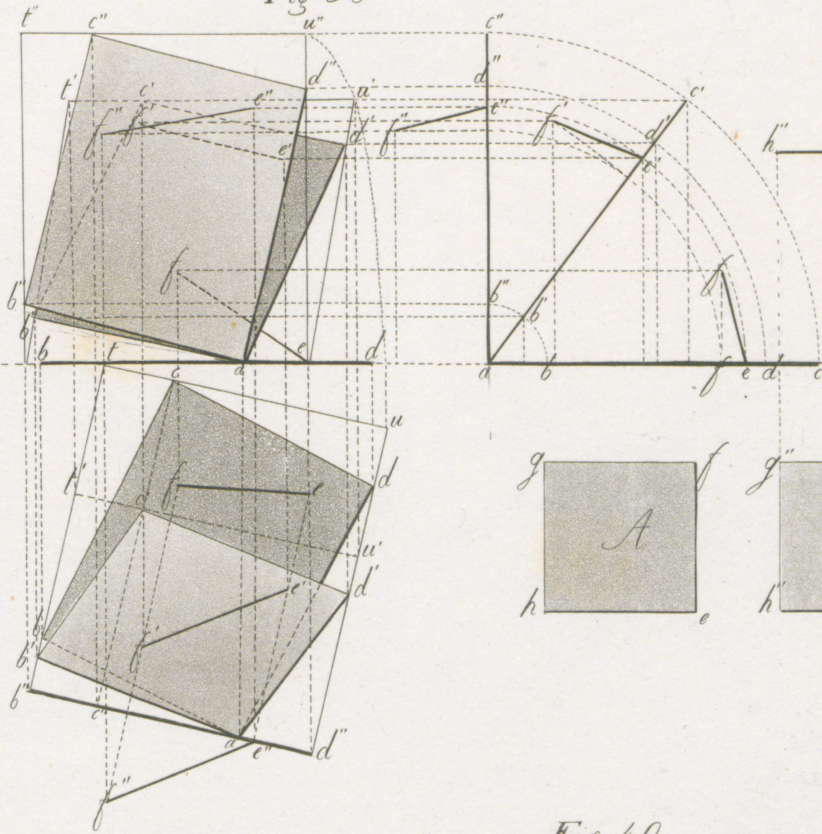

Fig 39

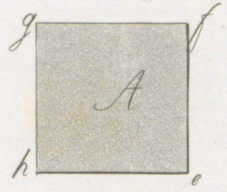
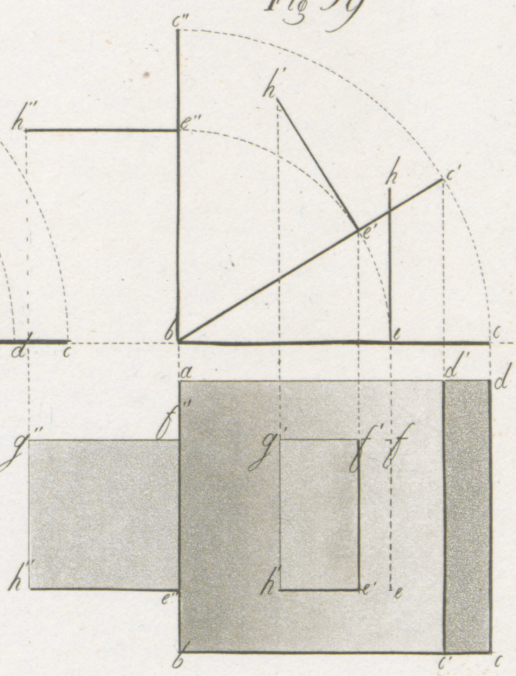

Fig 40

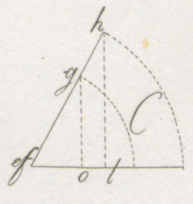
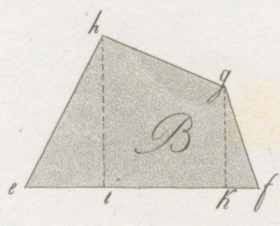
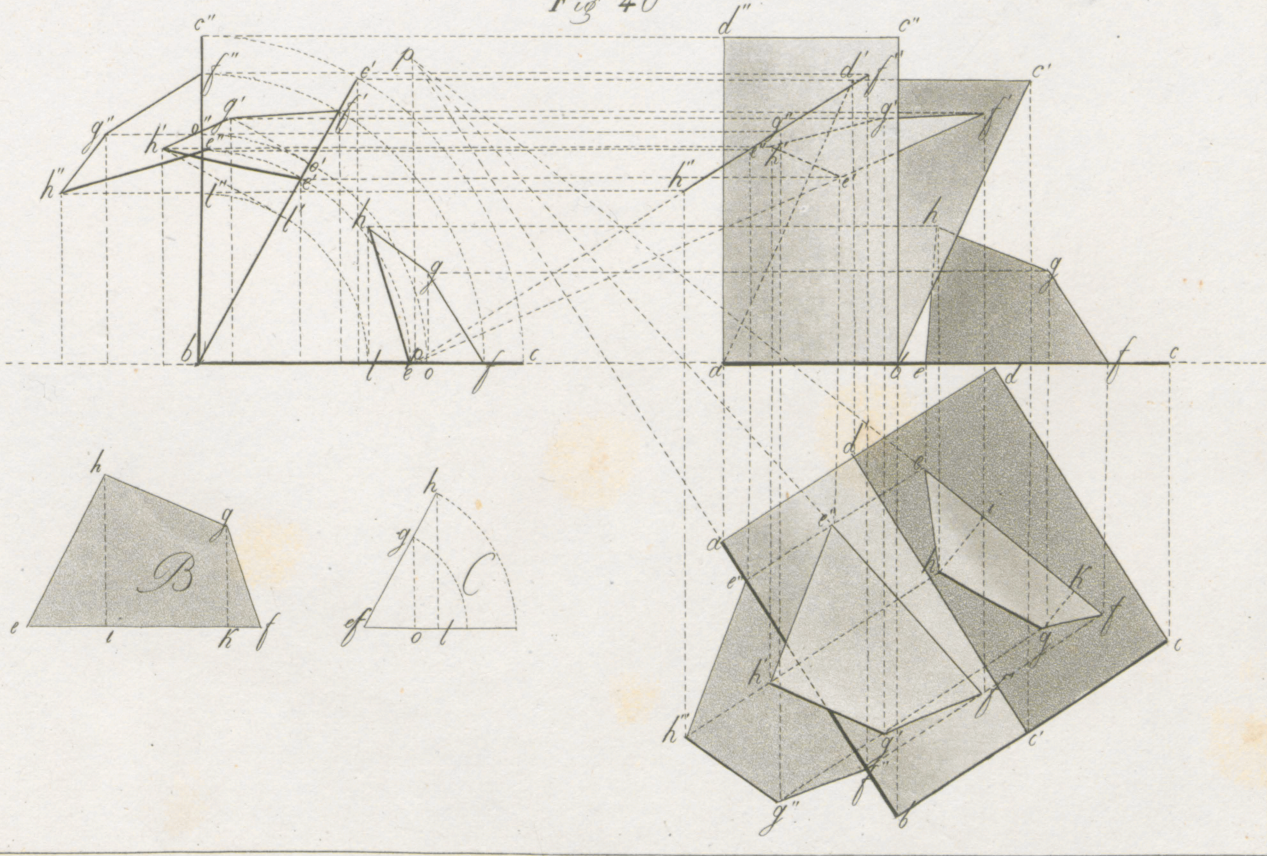

Fig 41

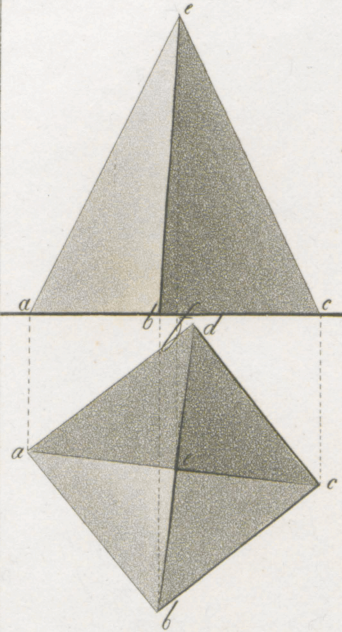

Fig 43

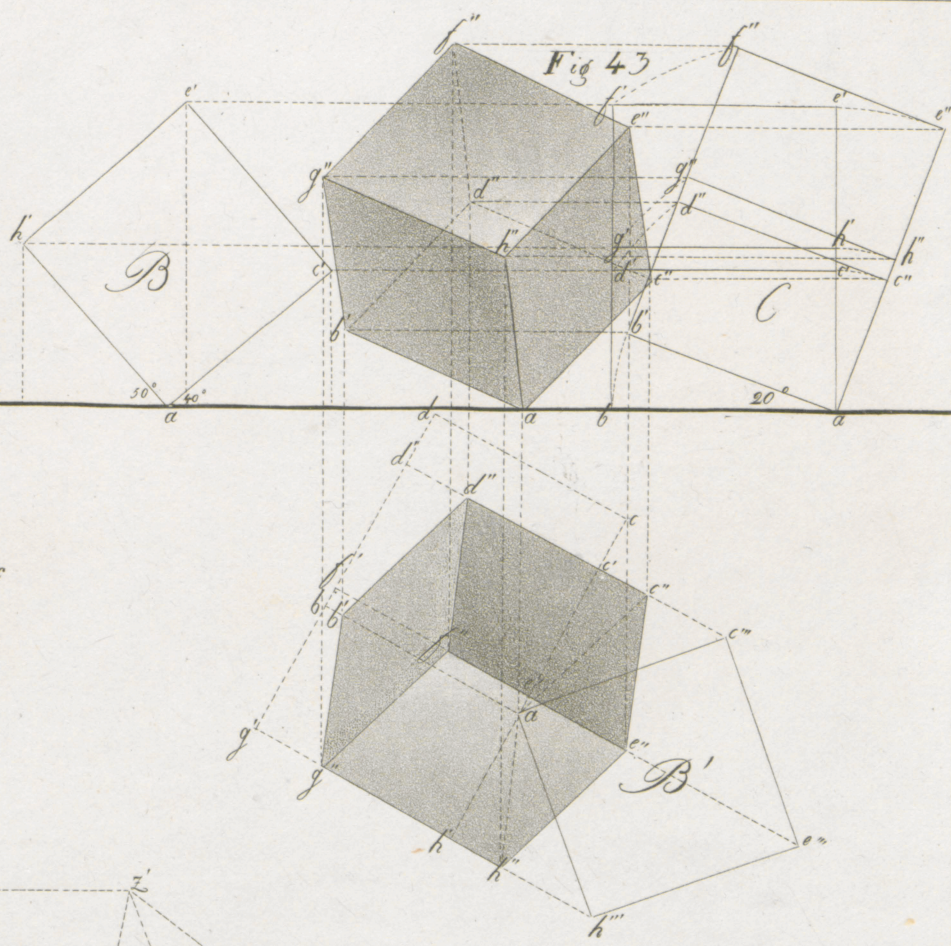

Fig 44

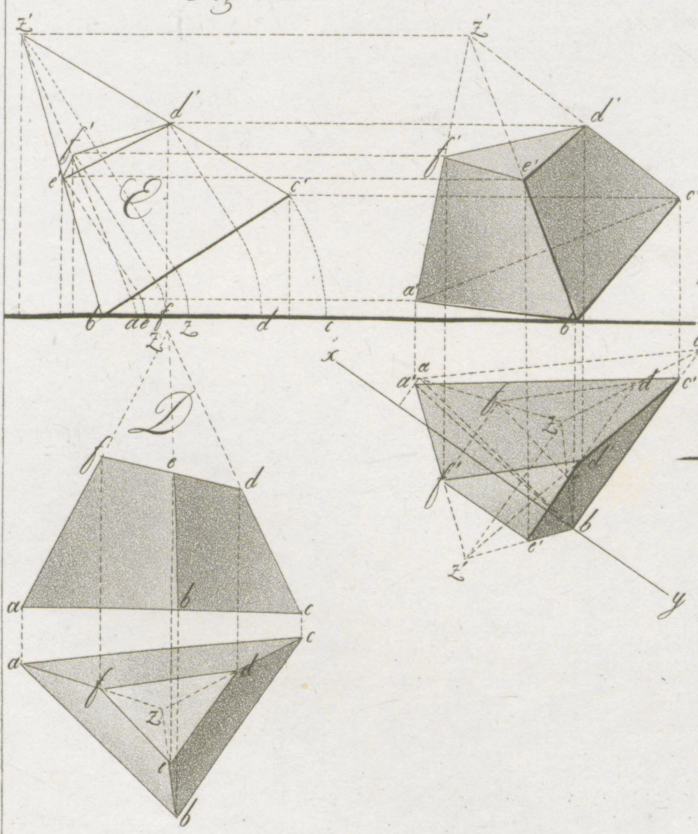

Fig 42

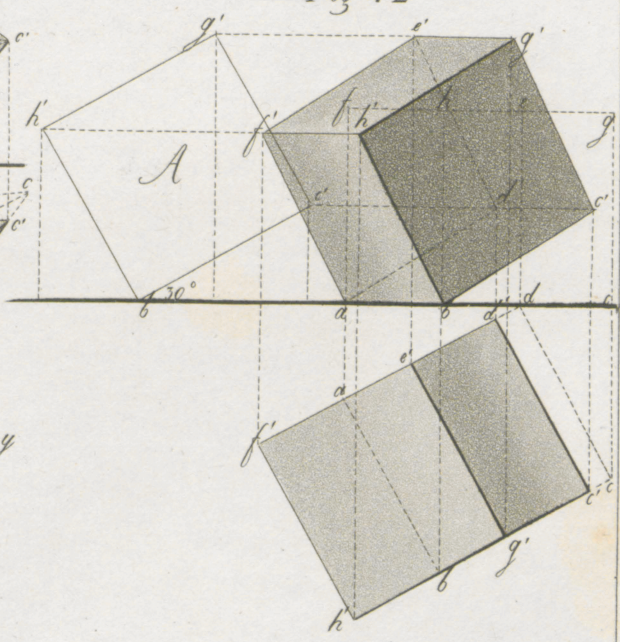

Fig 45

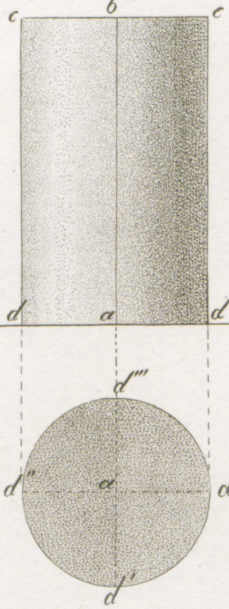

Fig 47

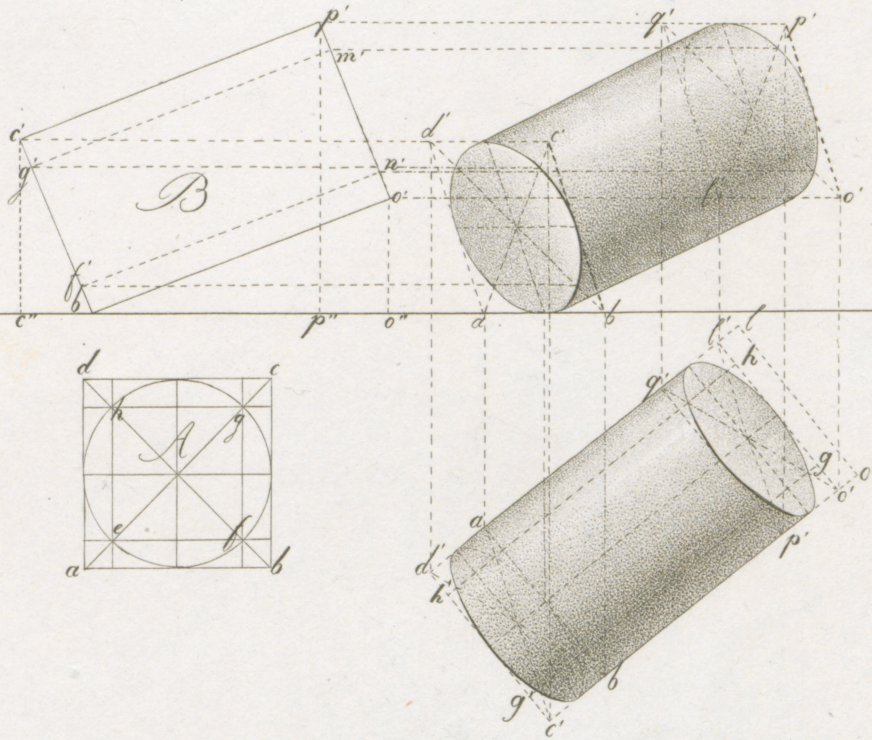

Fig 46

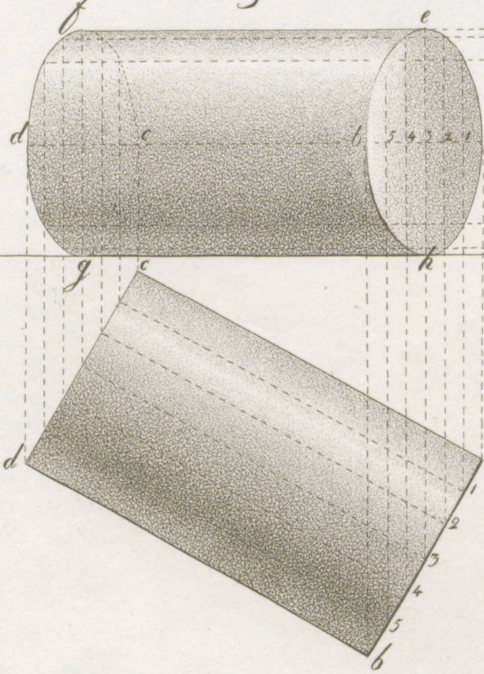
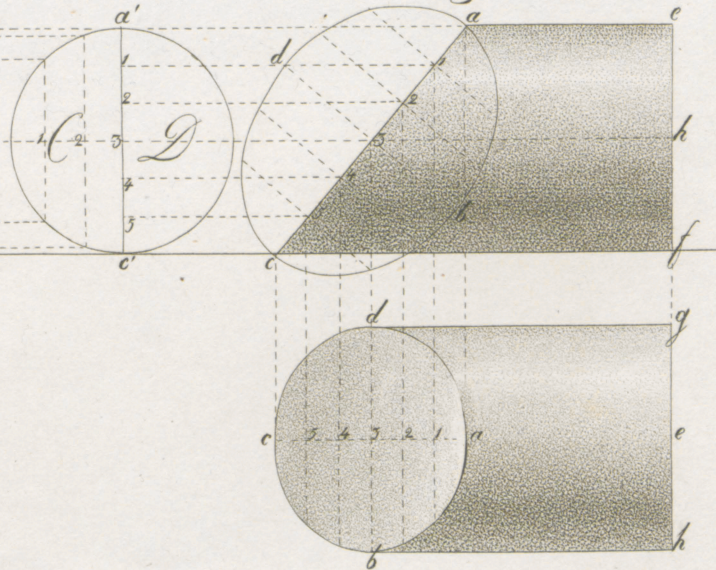

Fig 48



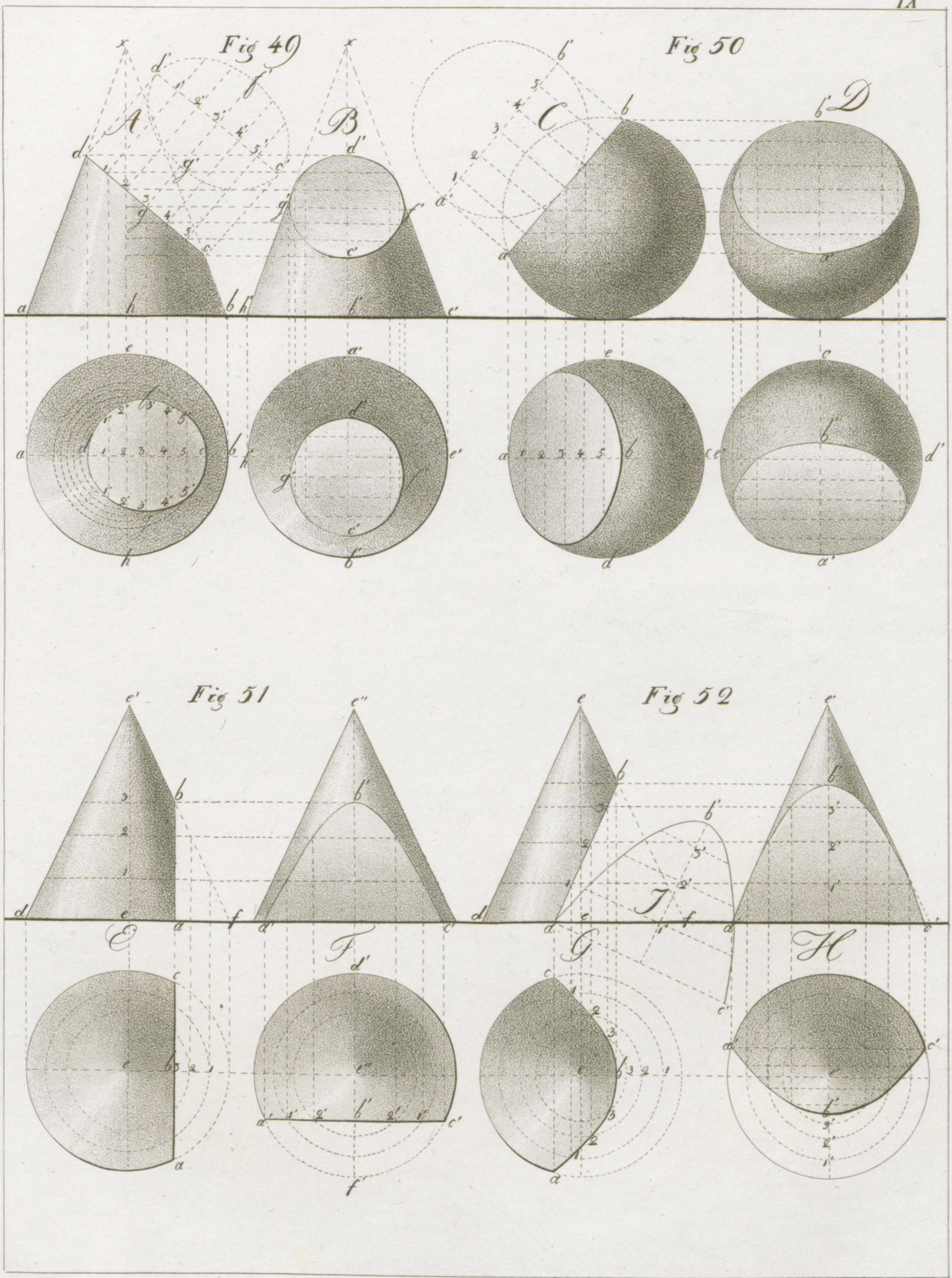

Fig 53

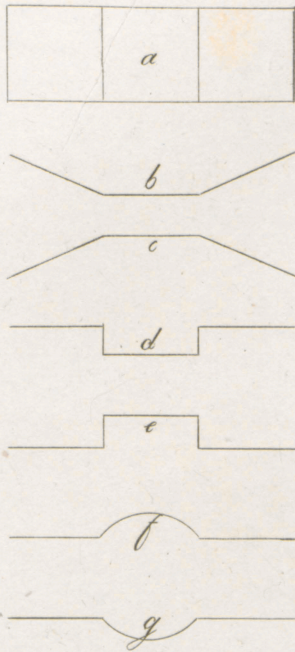

Fig 54

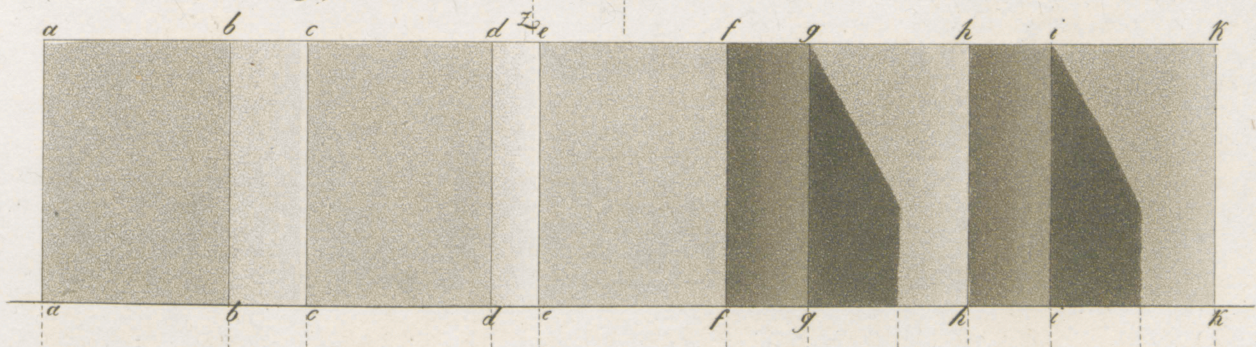
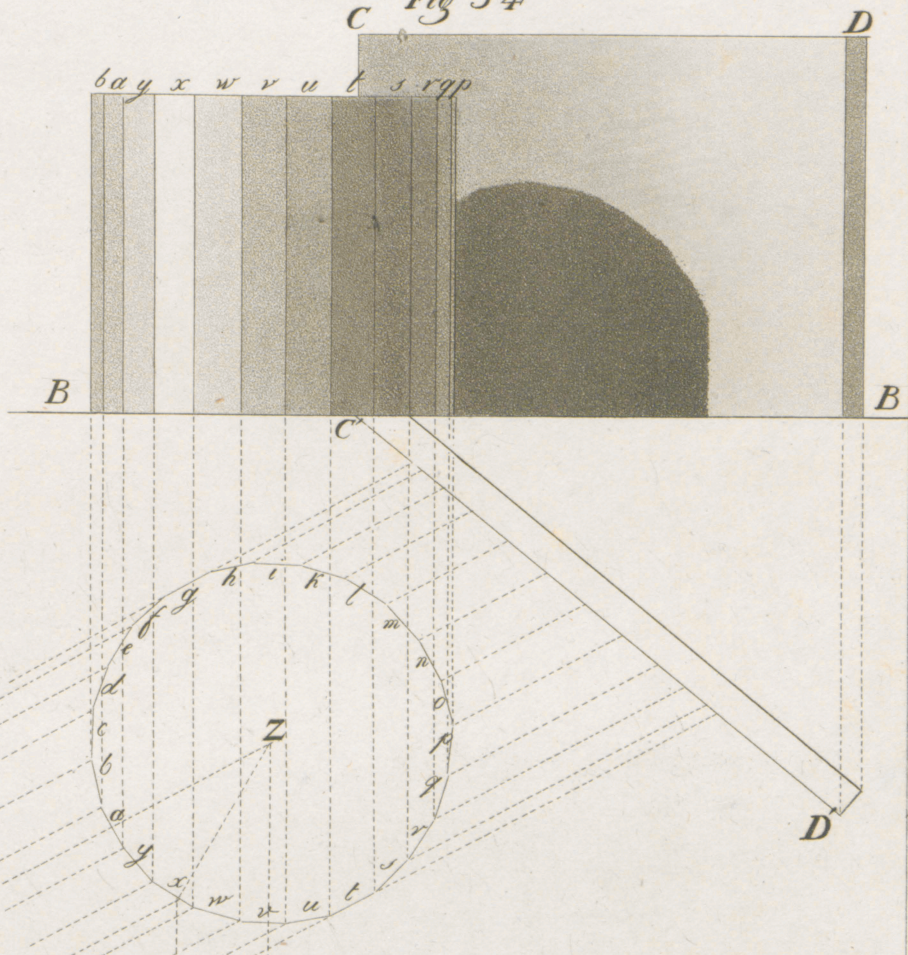
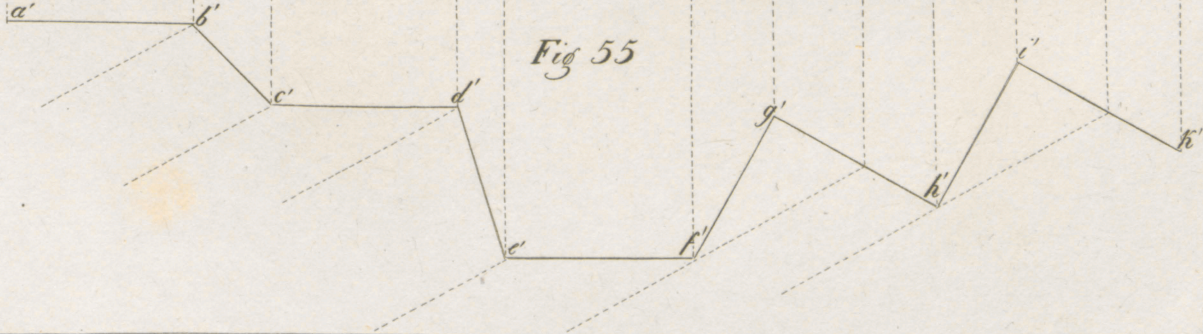

Fig 55



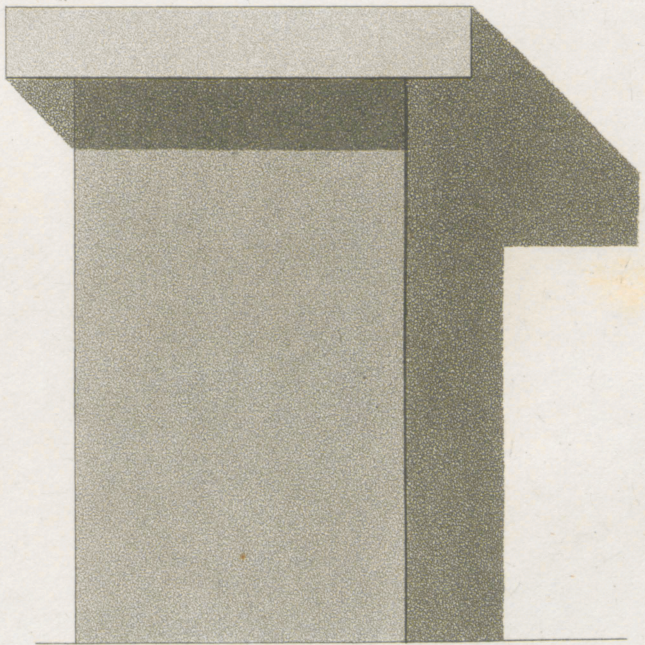
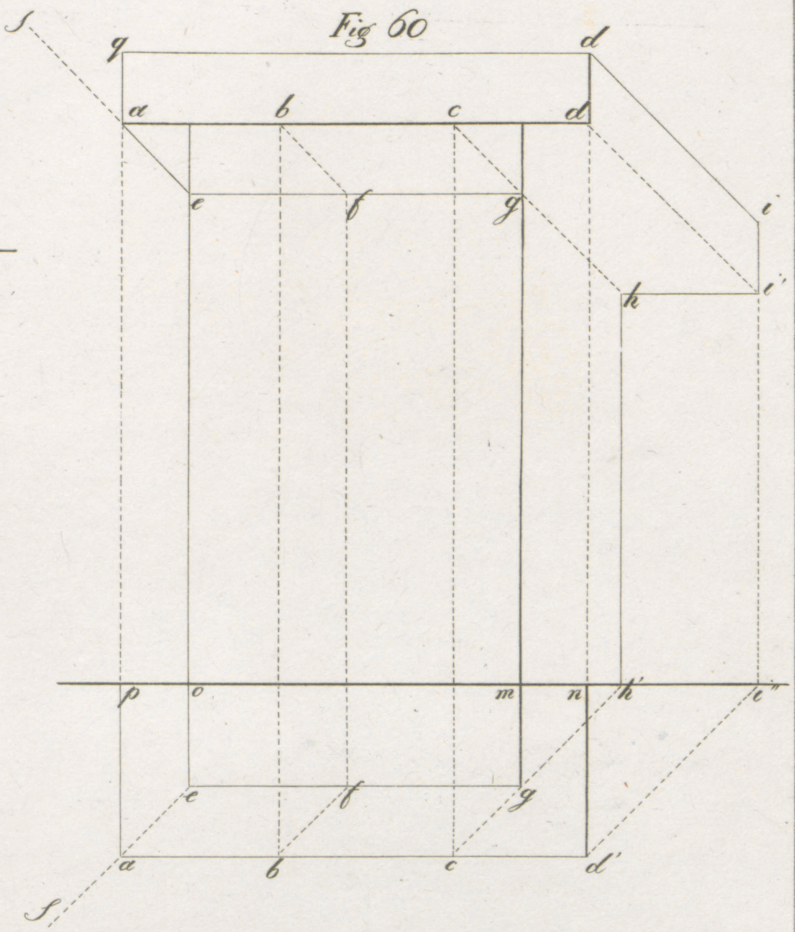
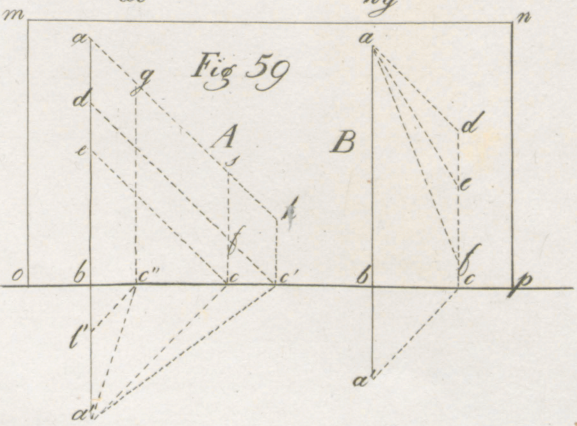
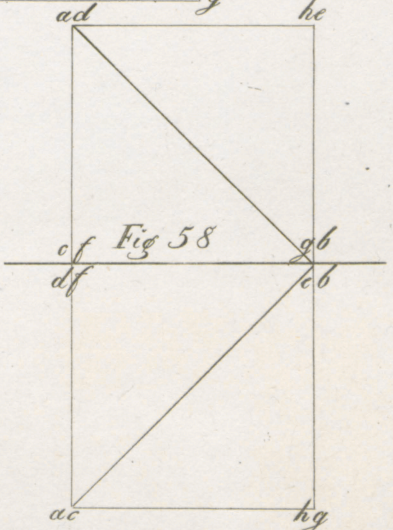
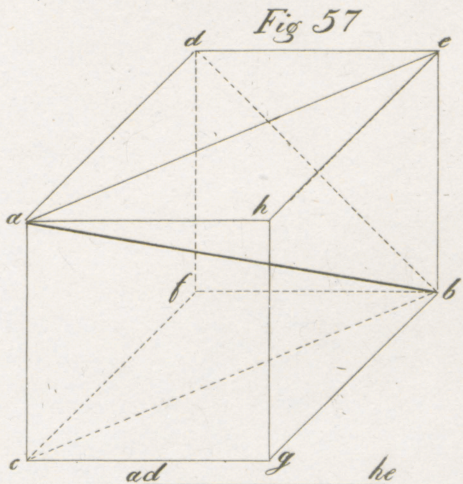
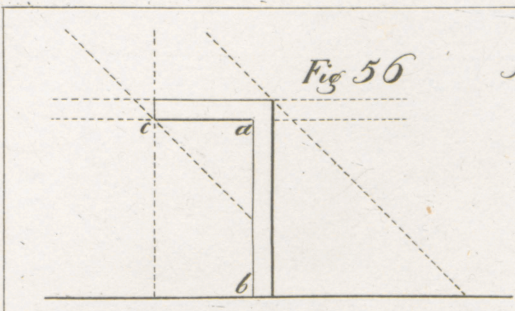

Fig 61

Fig 62

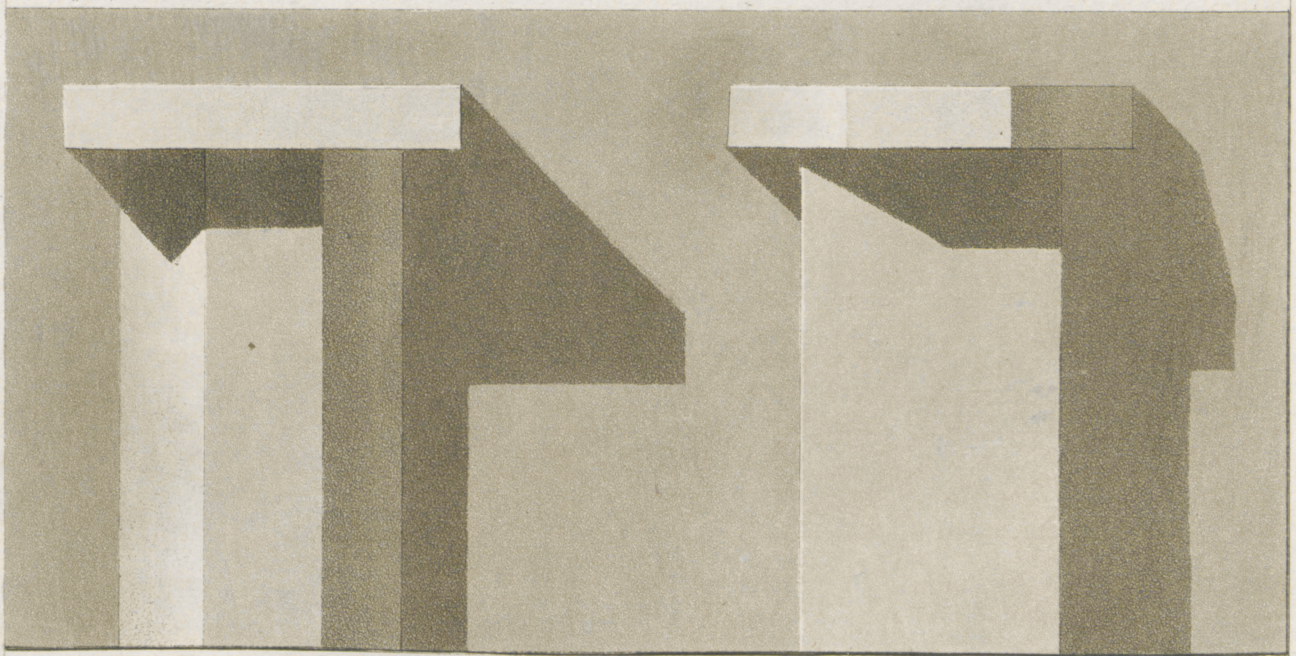
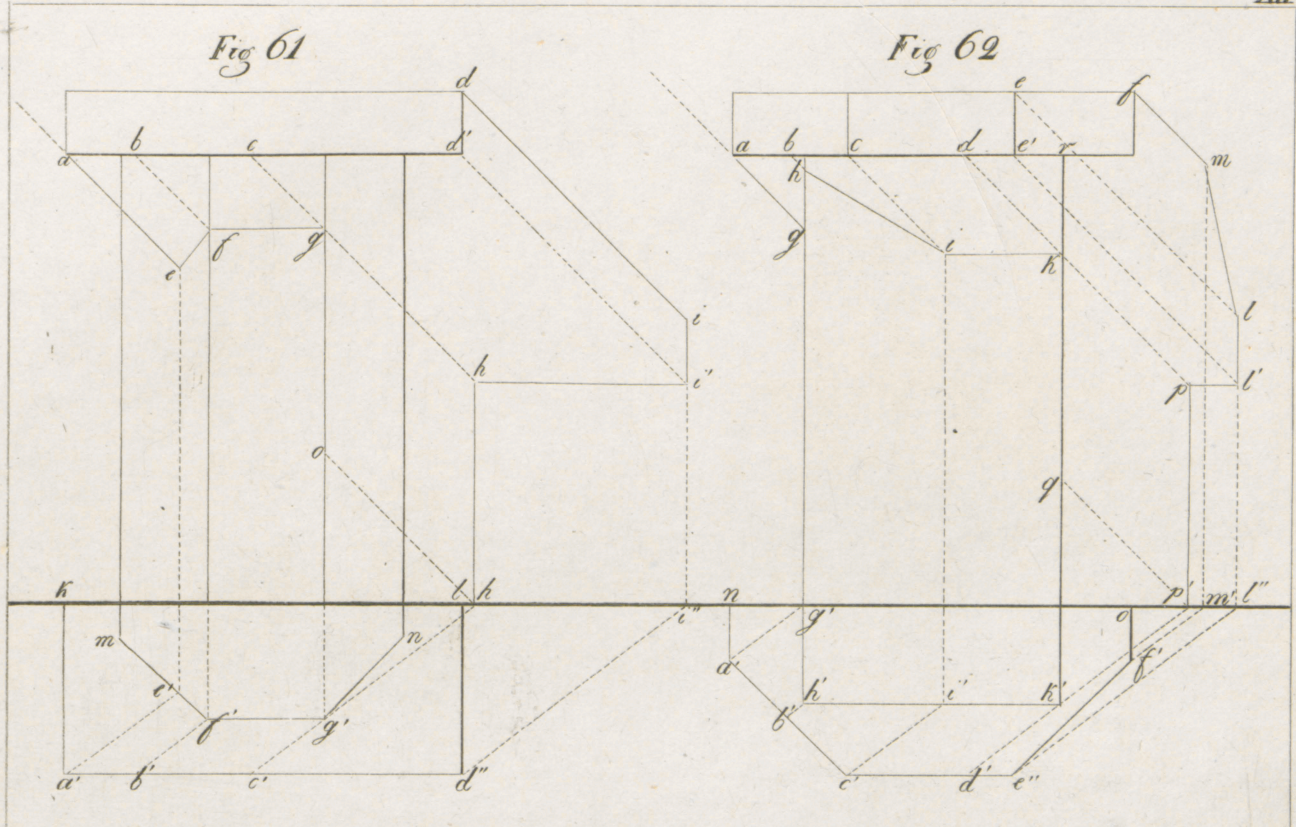

Fig 63

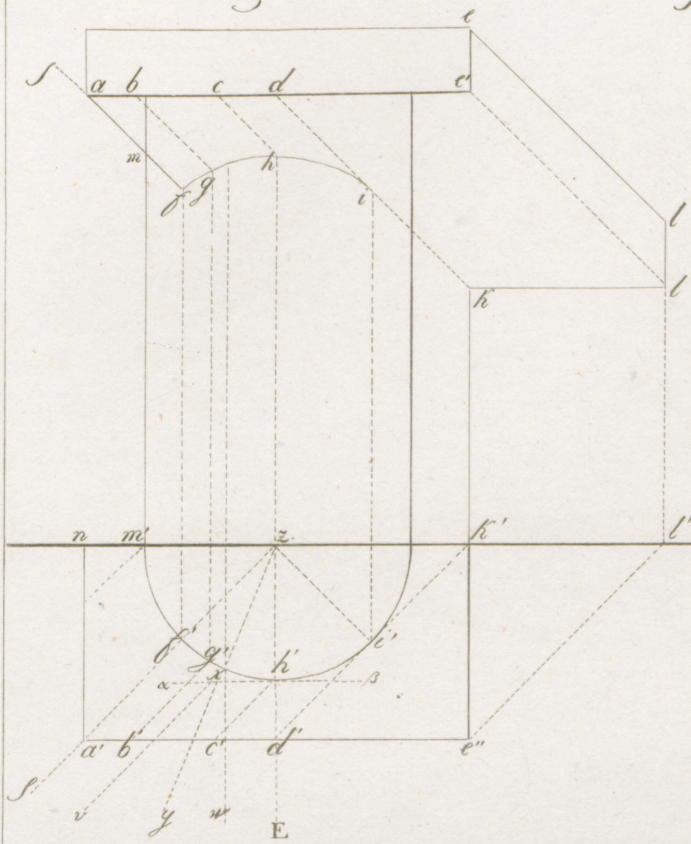

Fig 64

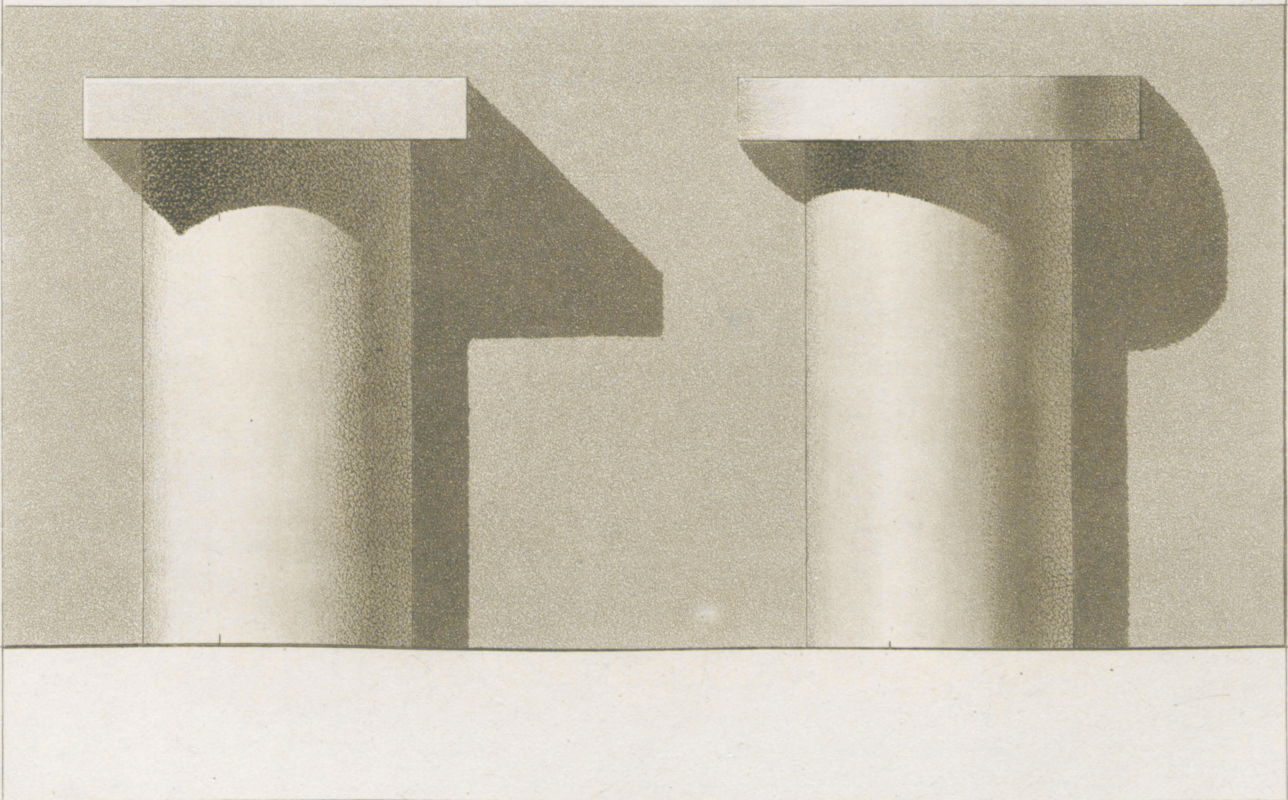
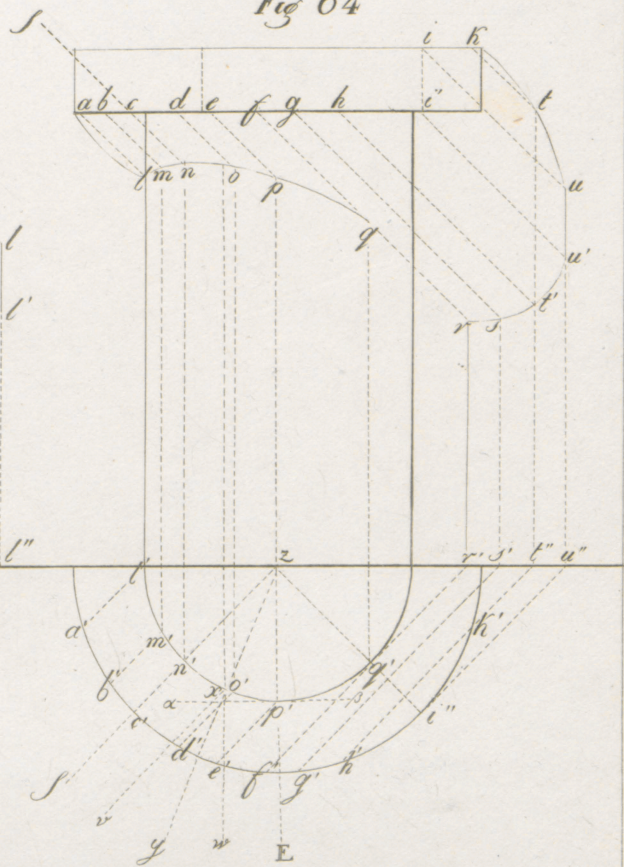

Fig 65

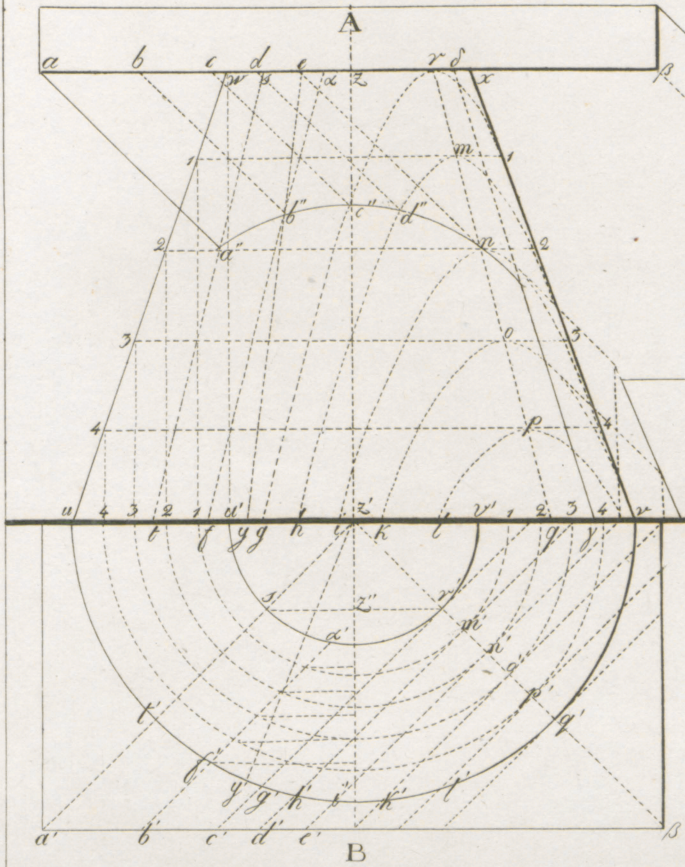

Fig 66

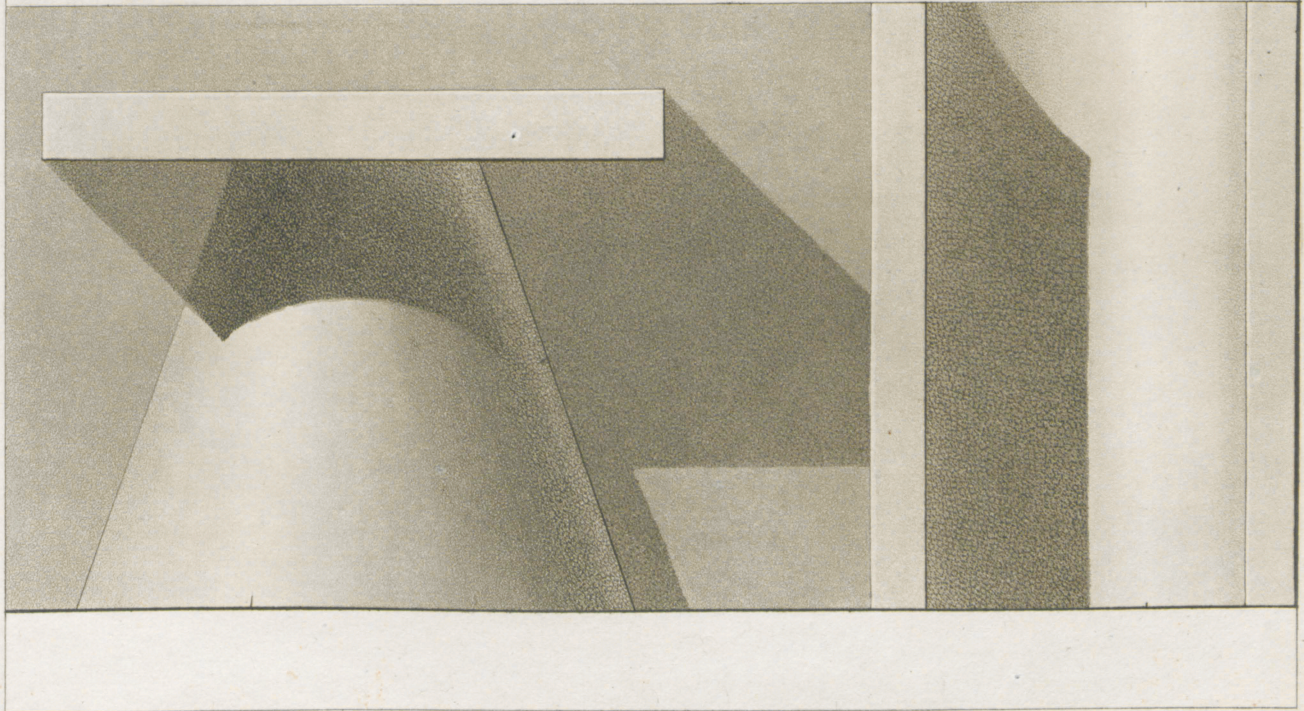

Fig 67

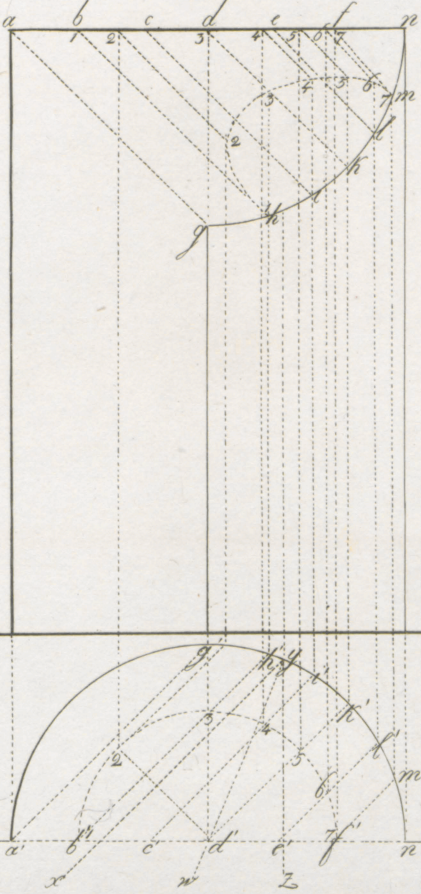
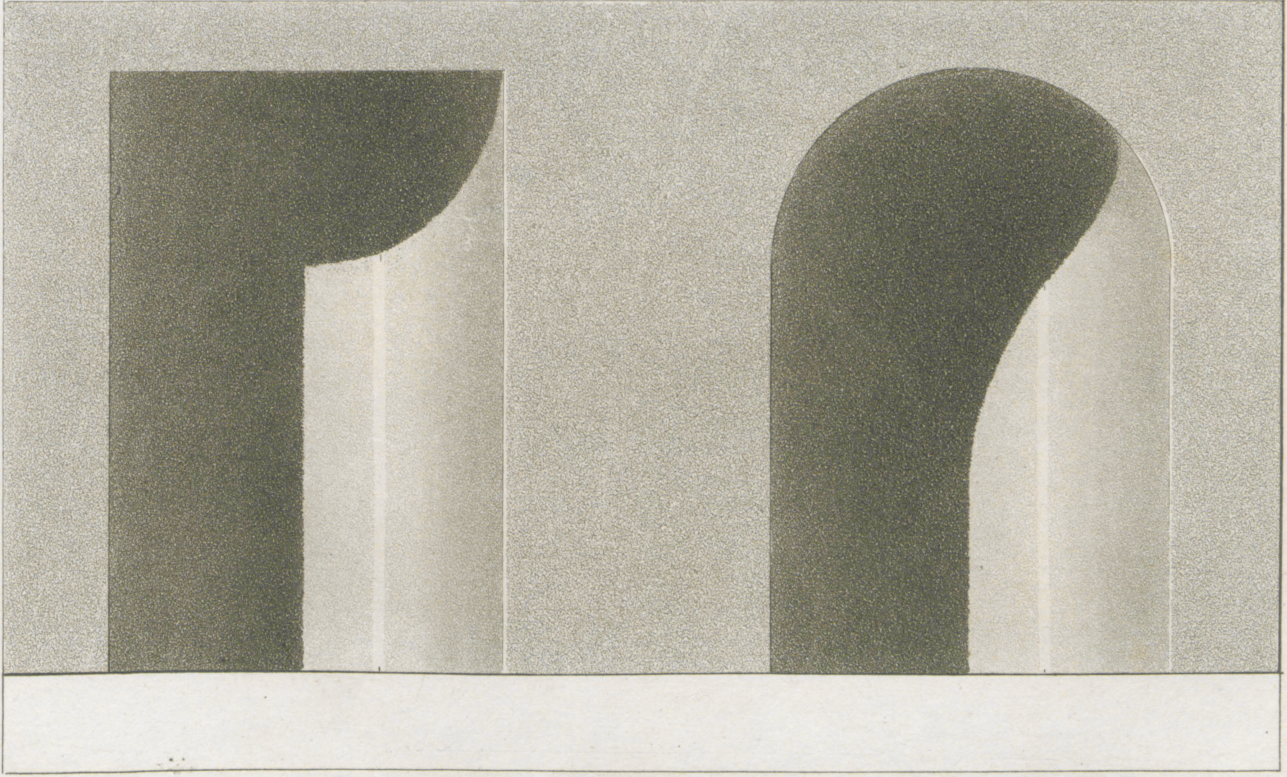
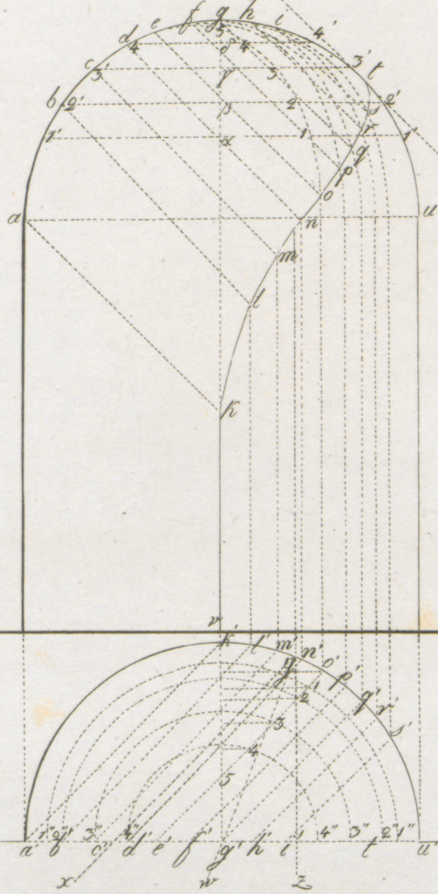

Fig 68



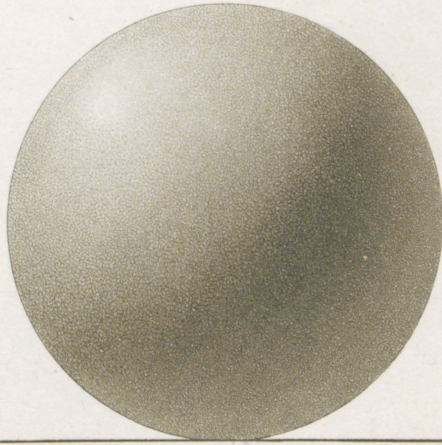

Fig 69

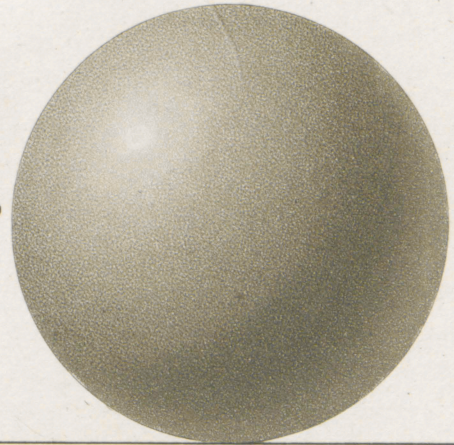

Fig 70

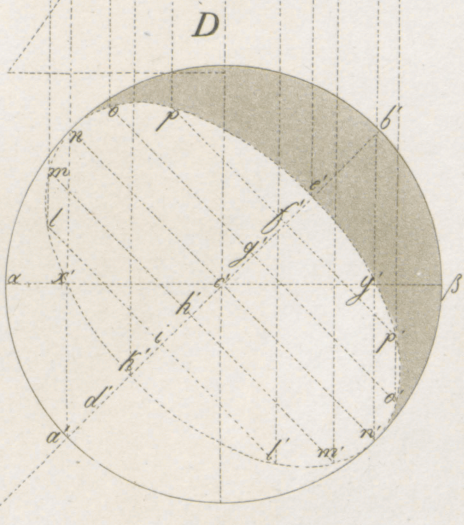
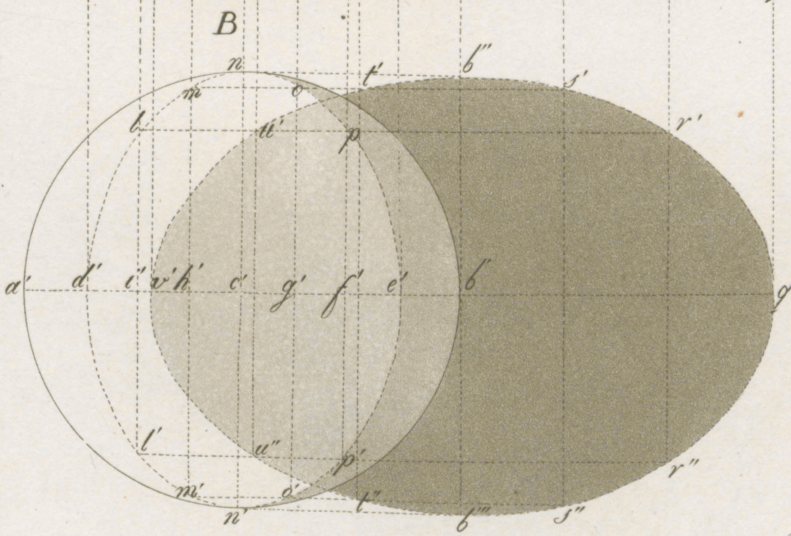
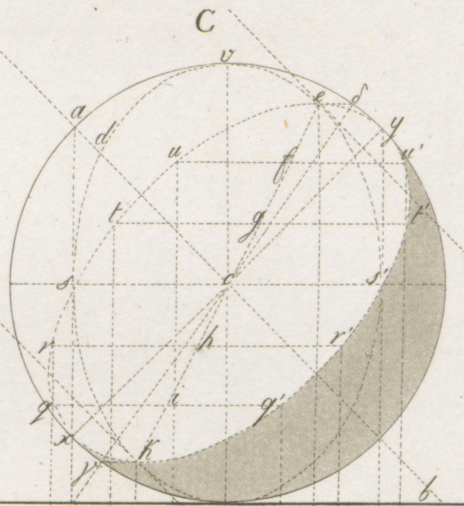
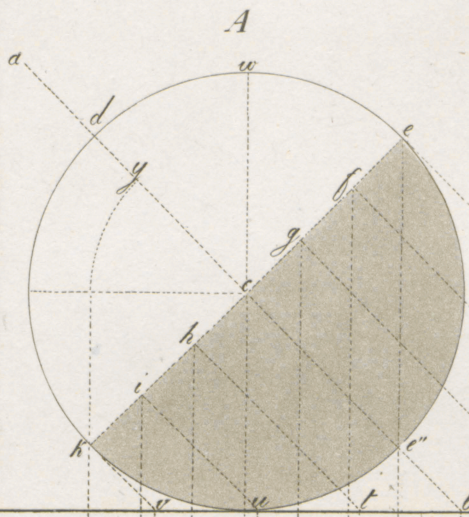

Fig 71

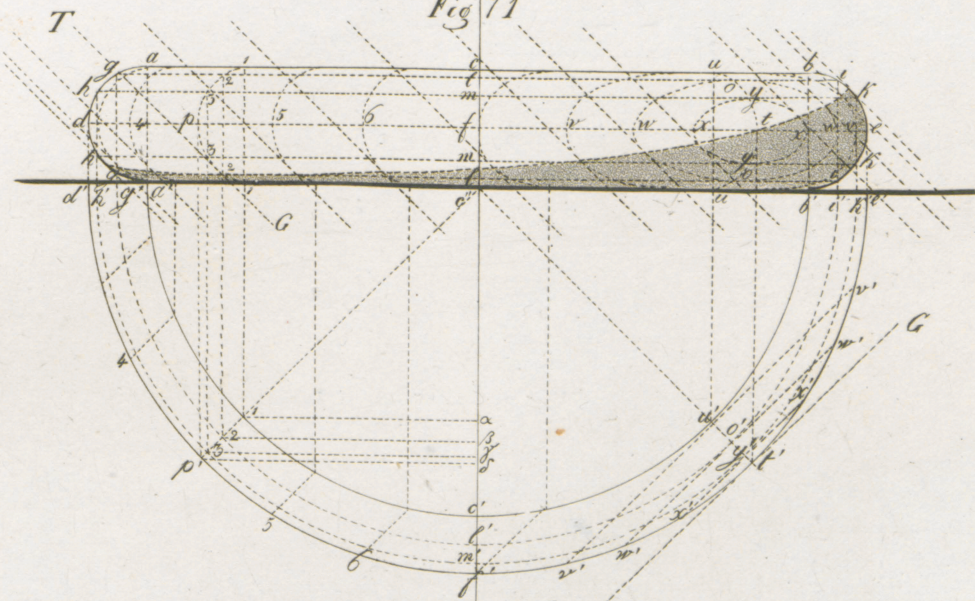
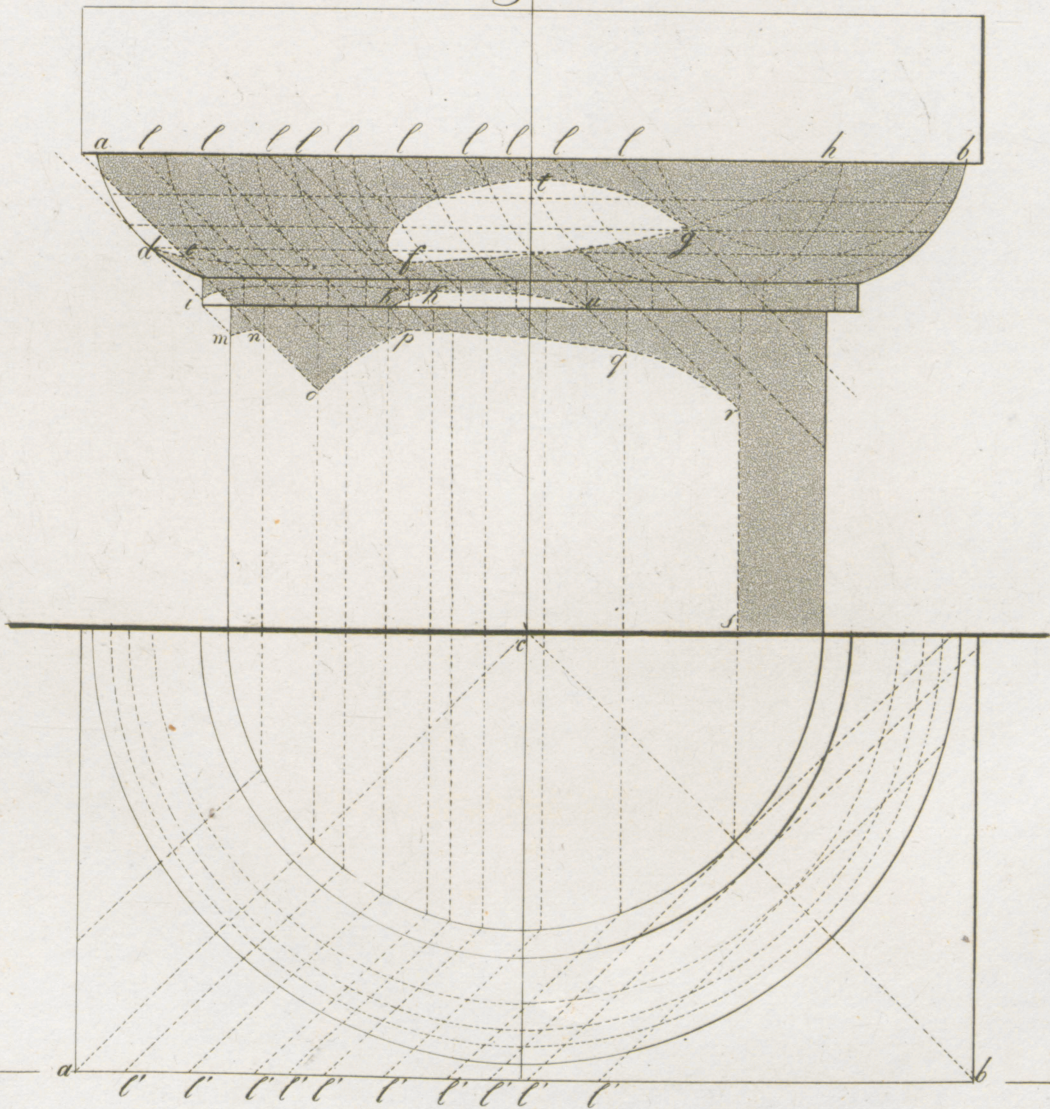

Fig 72 T



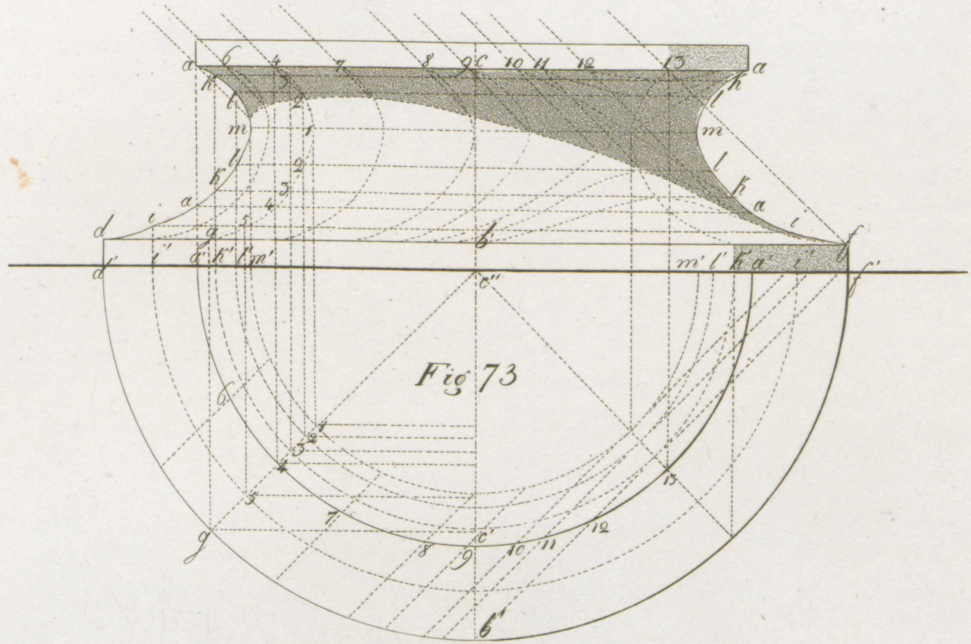

Fig 74

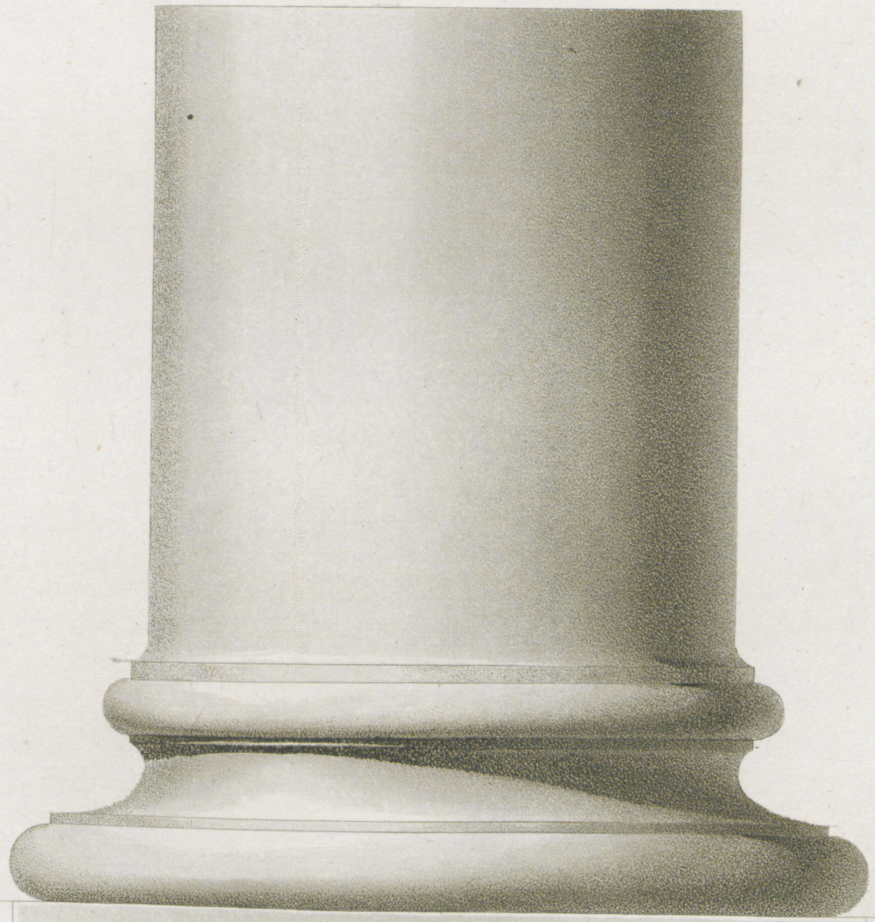

Fig 75

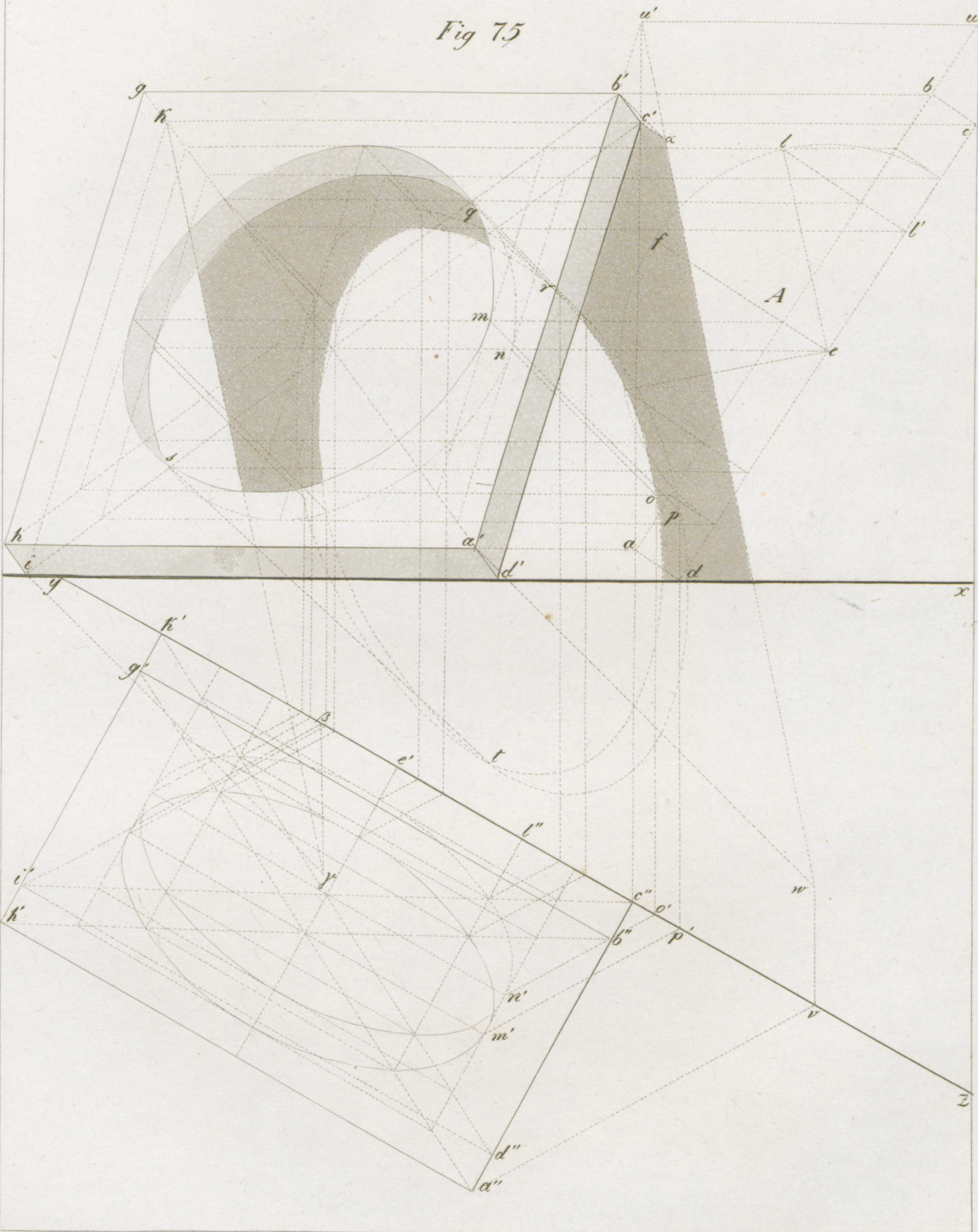
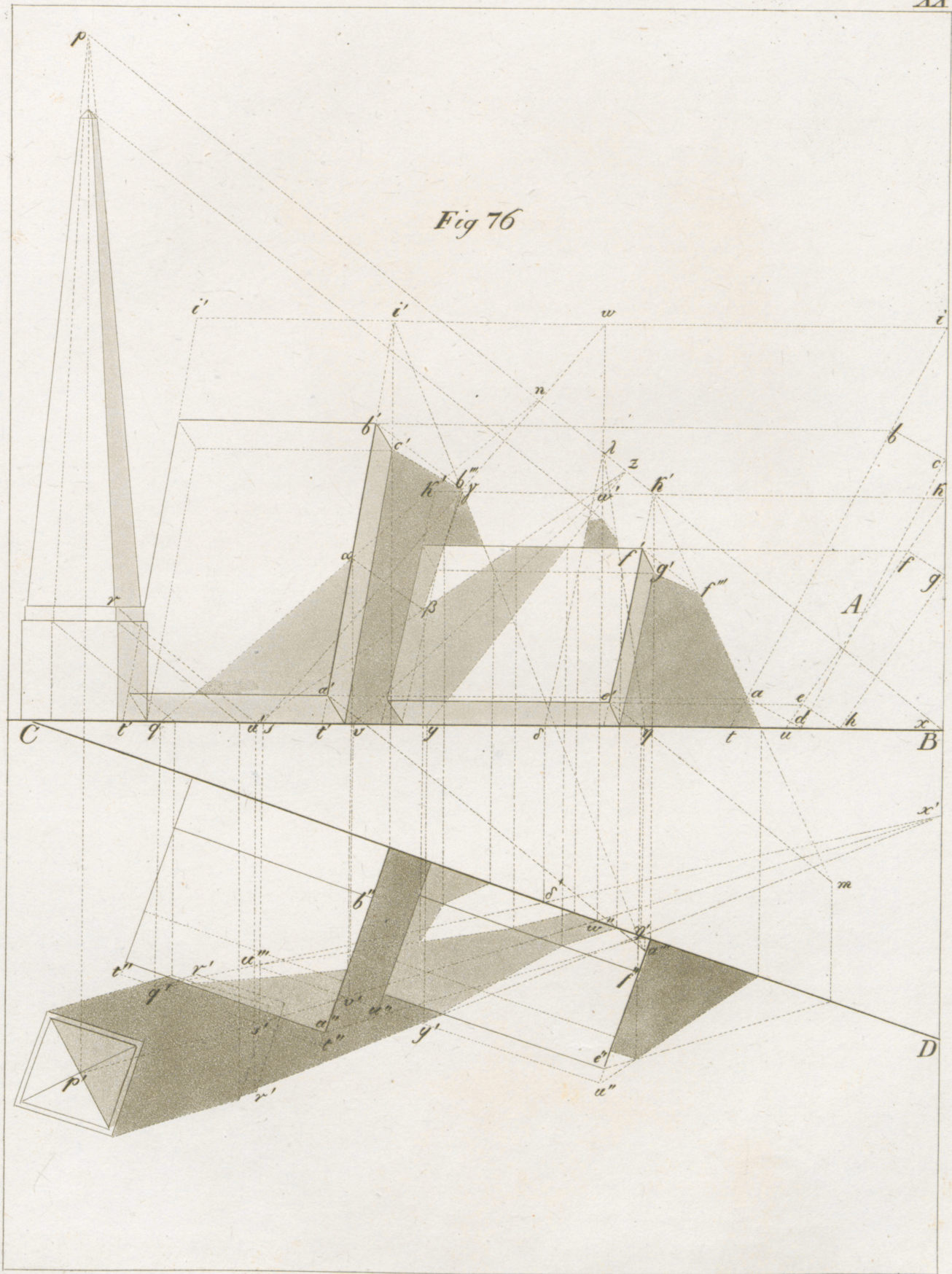

Fig 76



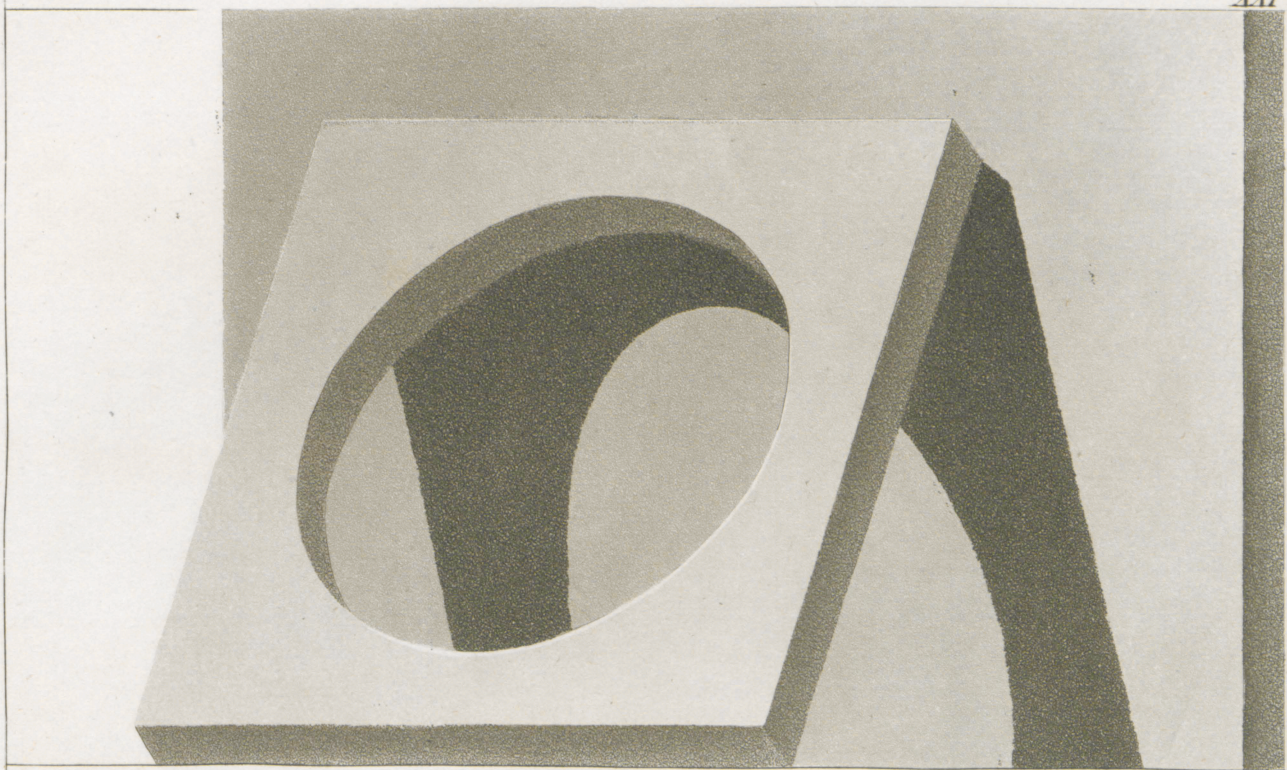

Fig 77

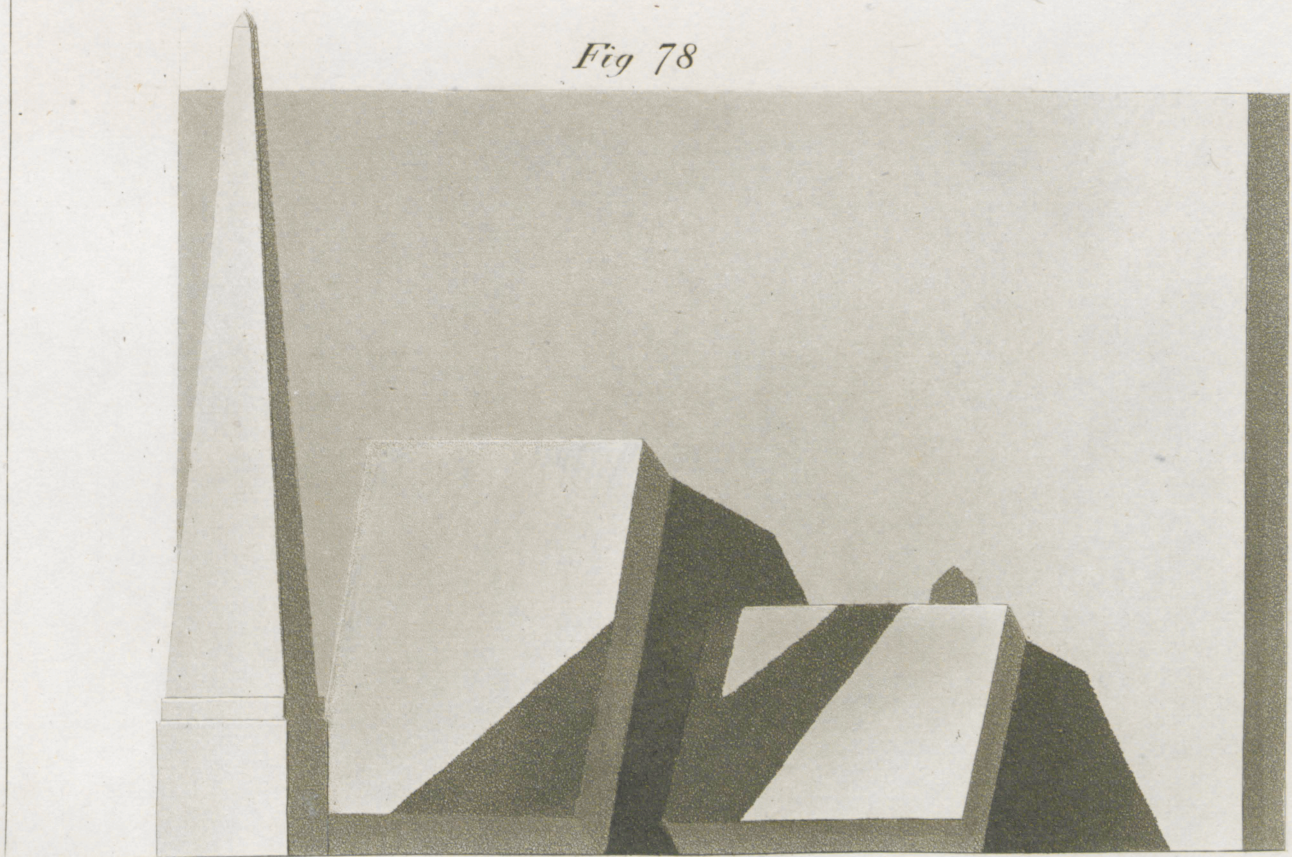

Fig 78

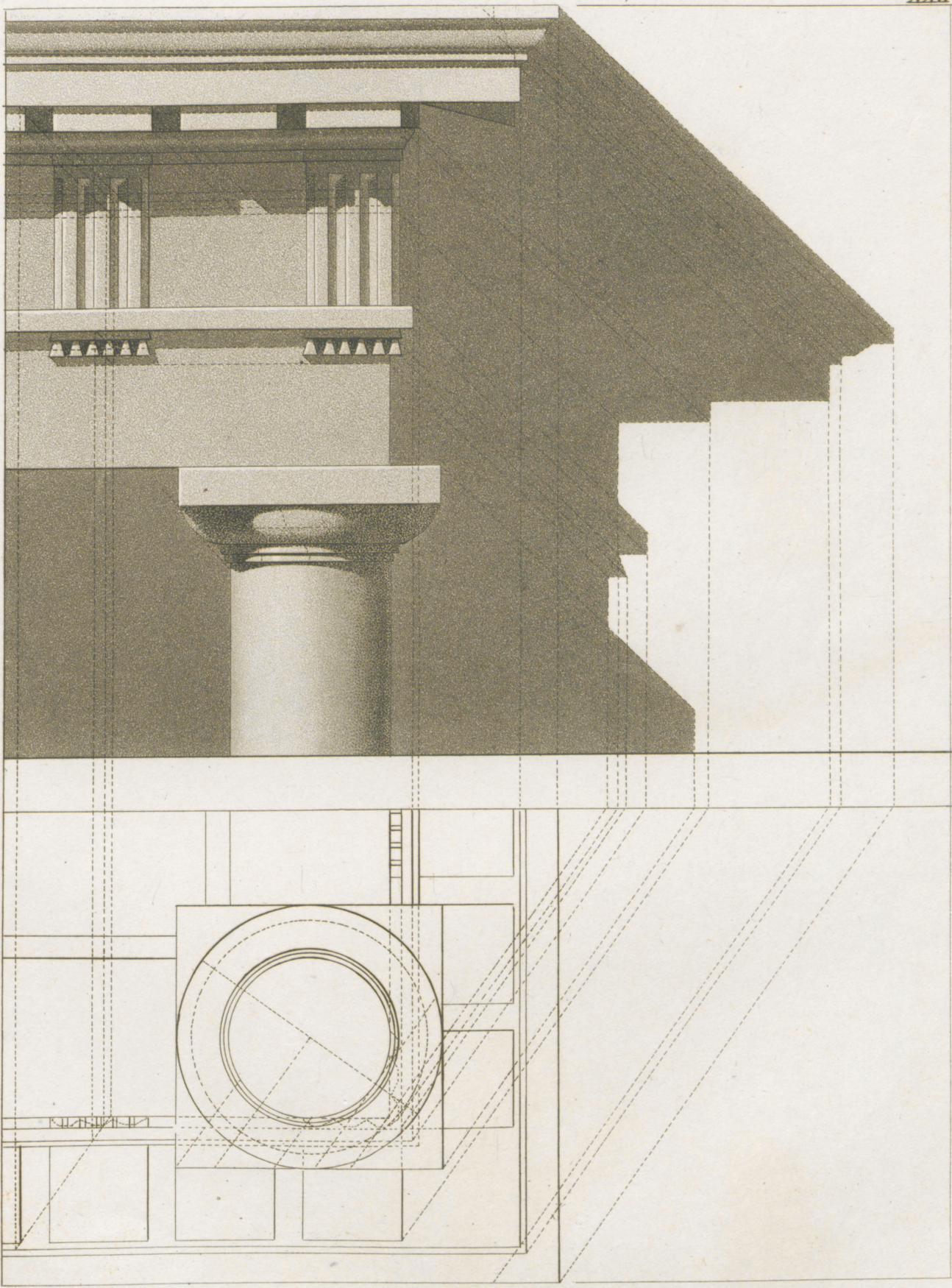

Fig 79



Fig 80

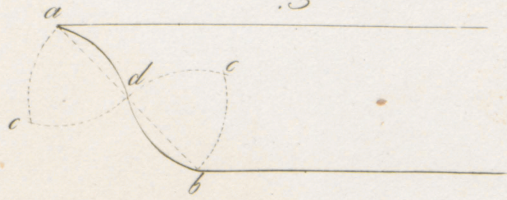

Fig 81

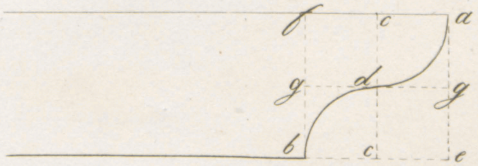

Fig 82

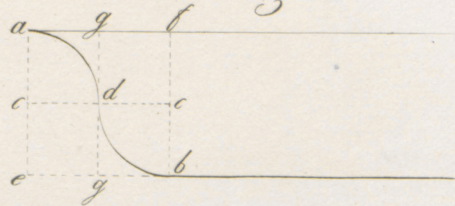

Fig 83

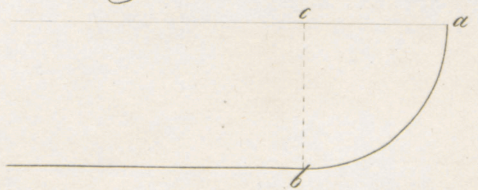

Fig 84

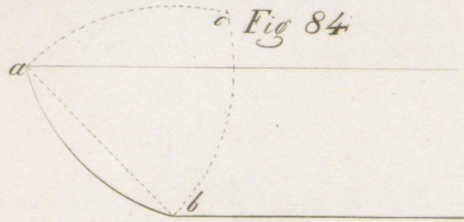

Fig 85

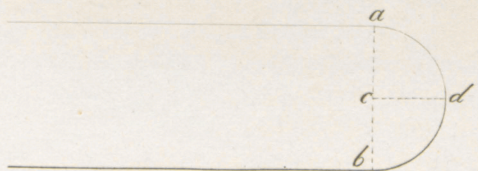

Fig 86

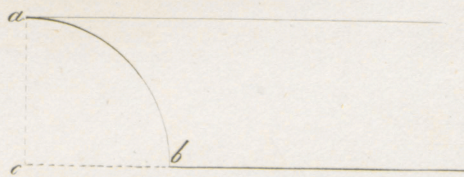
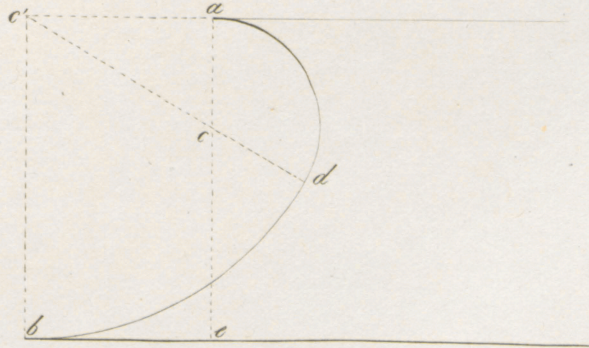
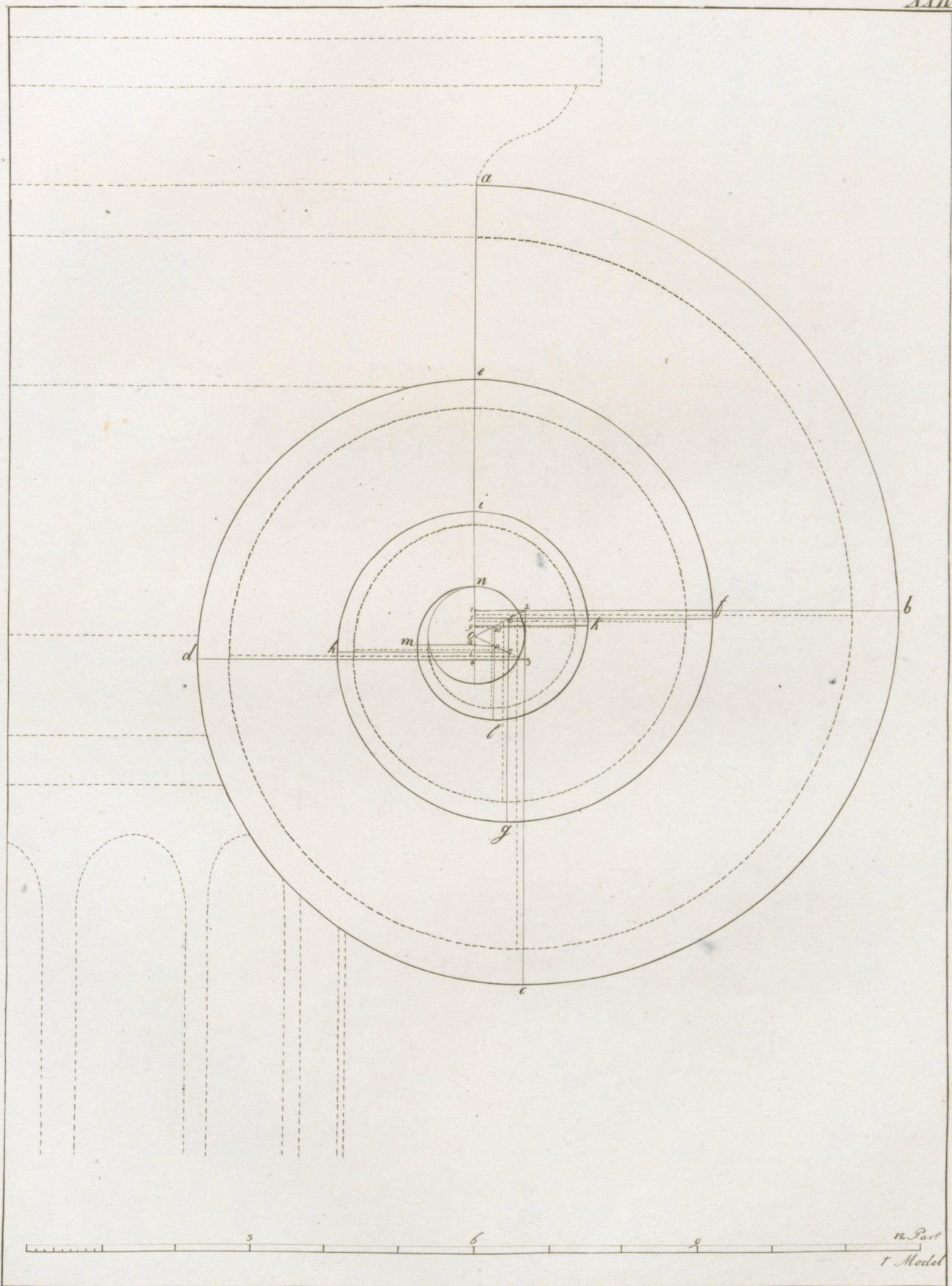

Fig 87







I 7 Model
II 8
III 9
IV & V 10

N^o

I

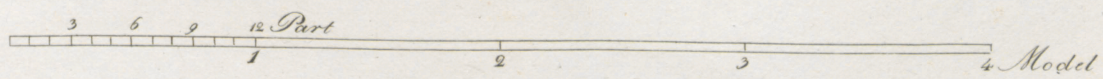
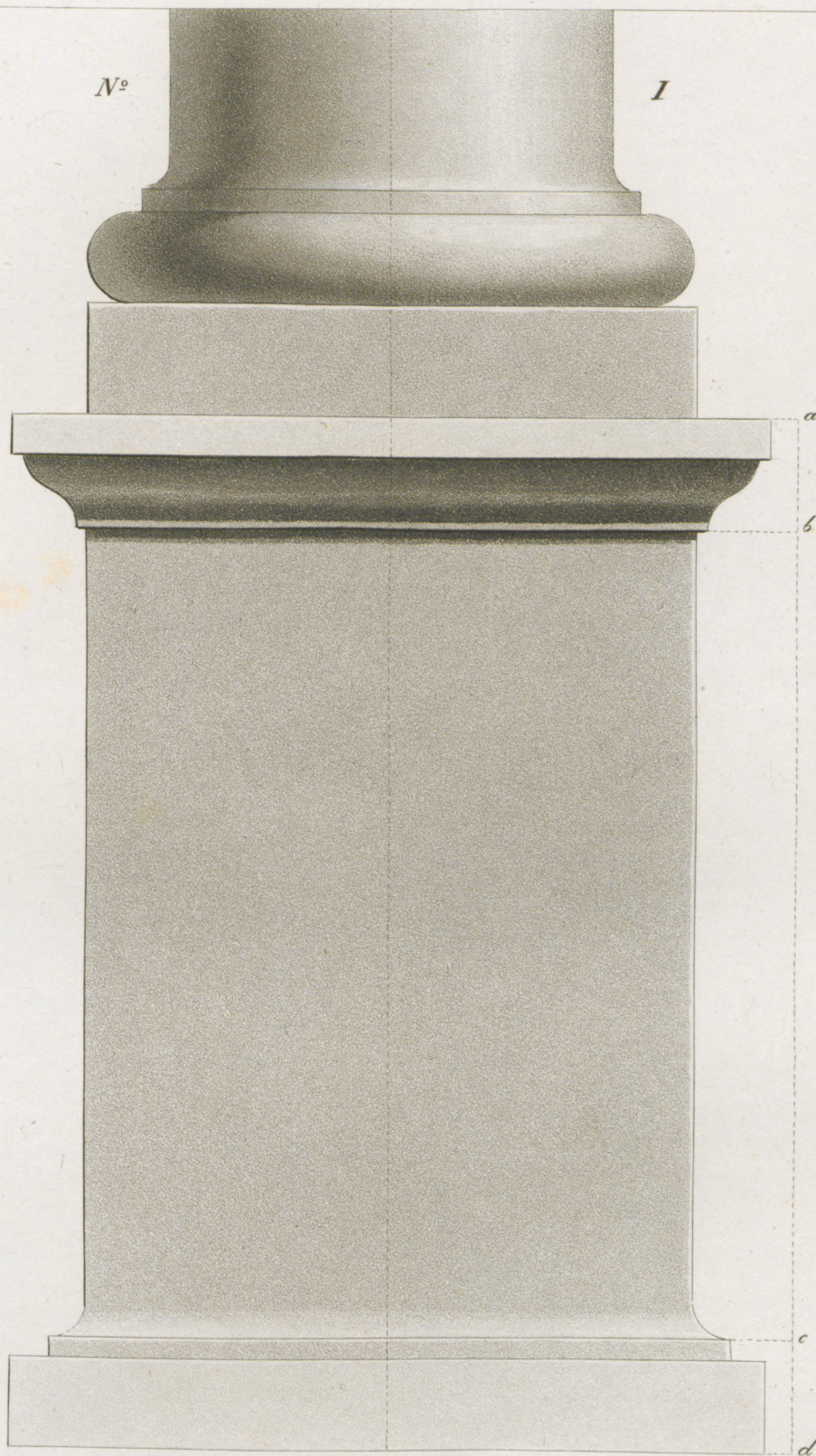

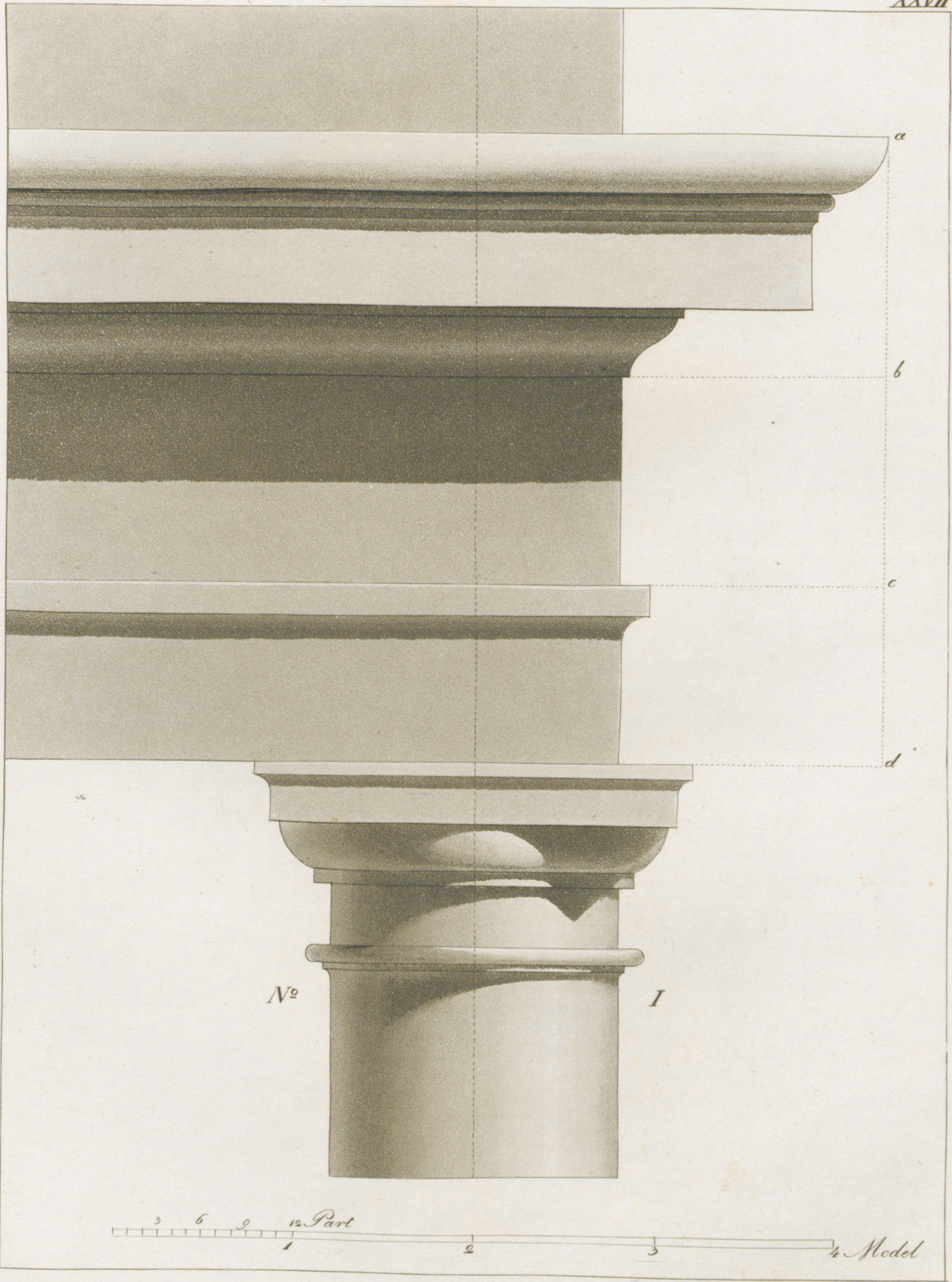

N^o

I

3 6 9 12 Part 1 2 3 4 Model

N^o

II

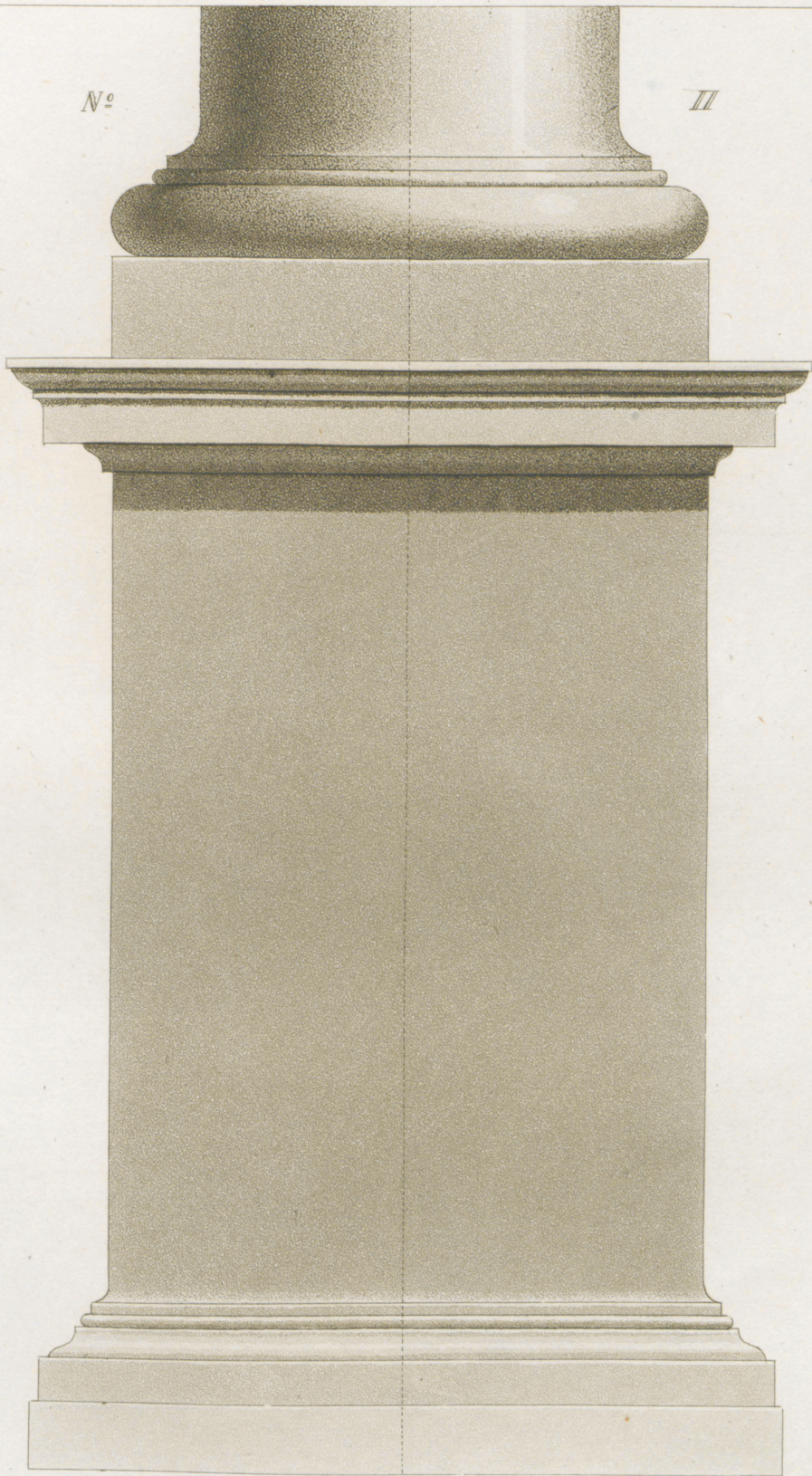



3 6 9 12 Part 1 2 3 4 Model

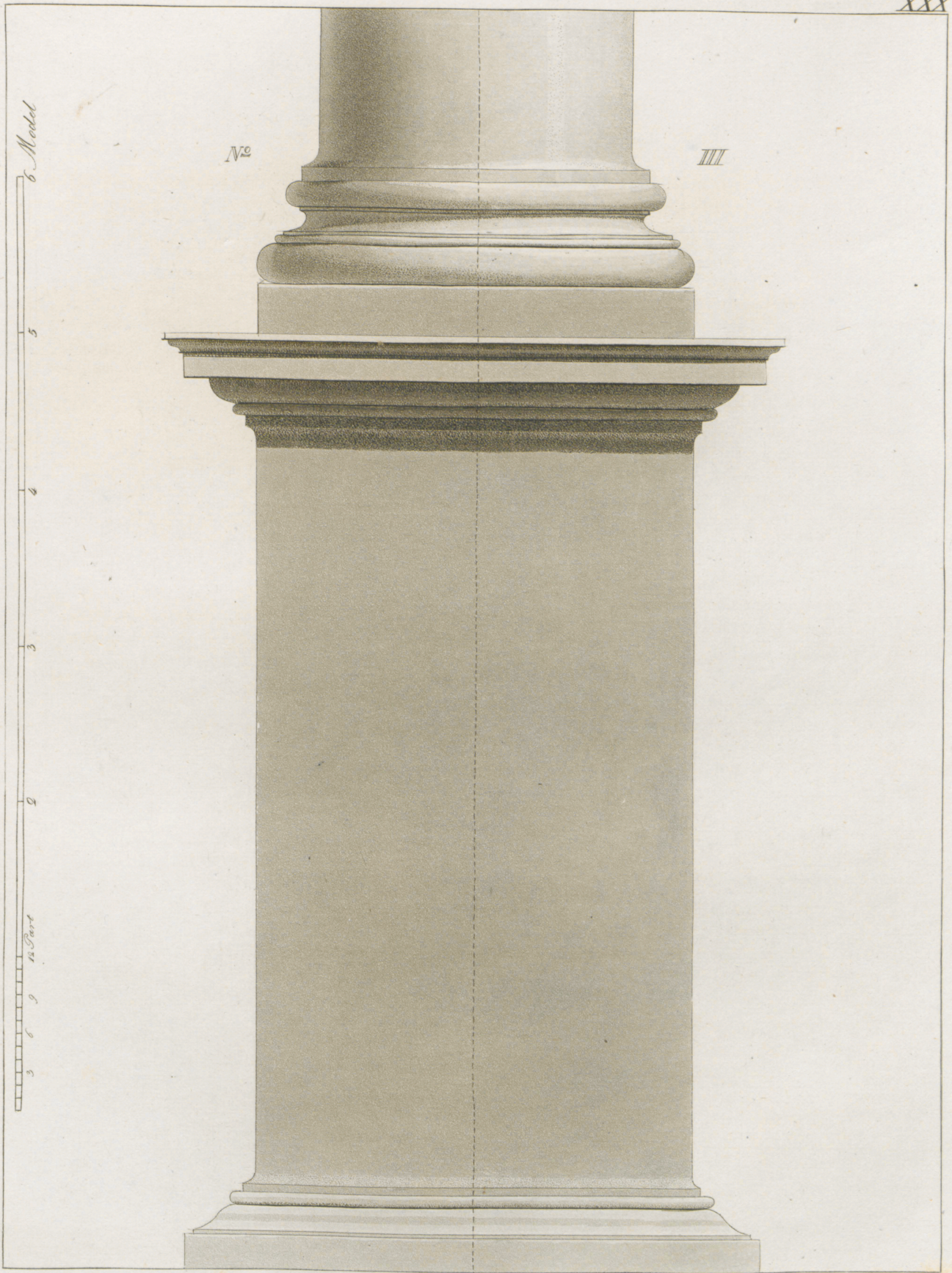

6 Moulds

No

III

14 Parts

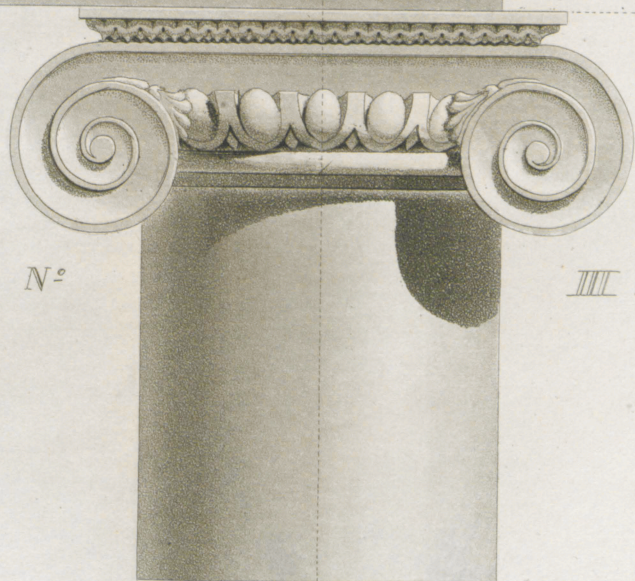
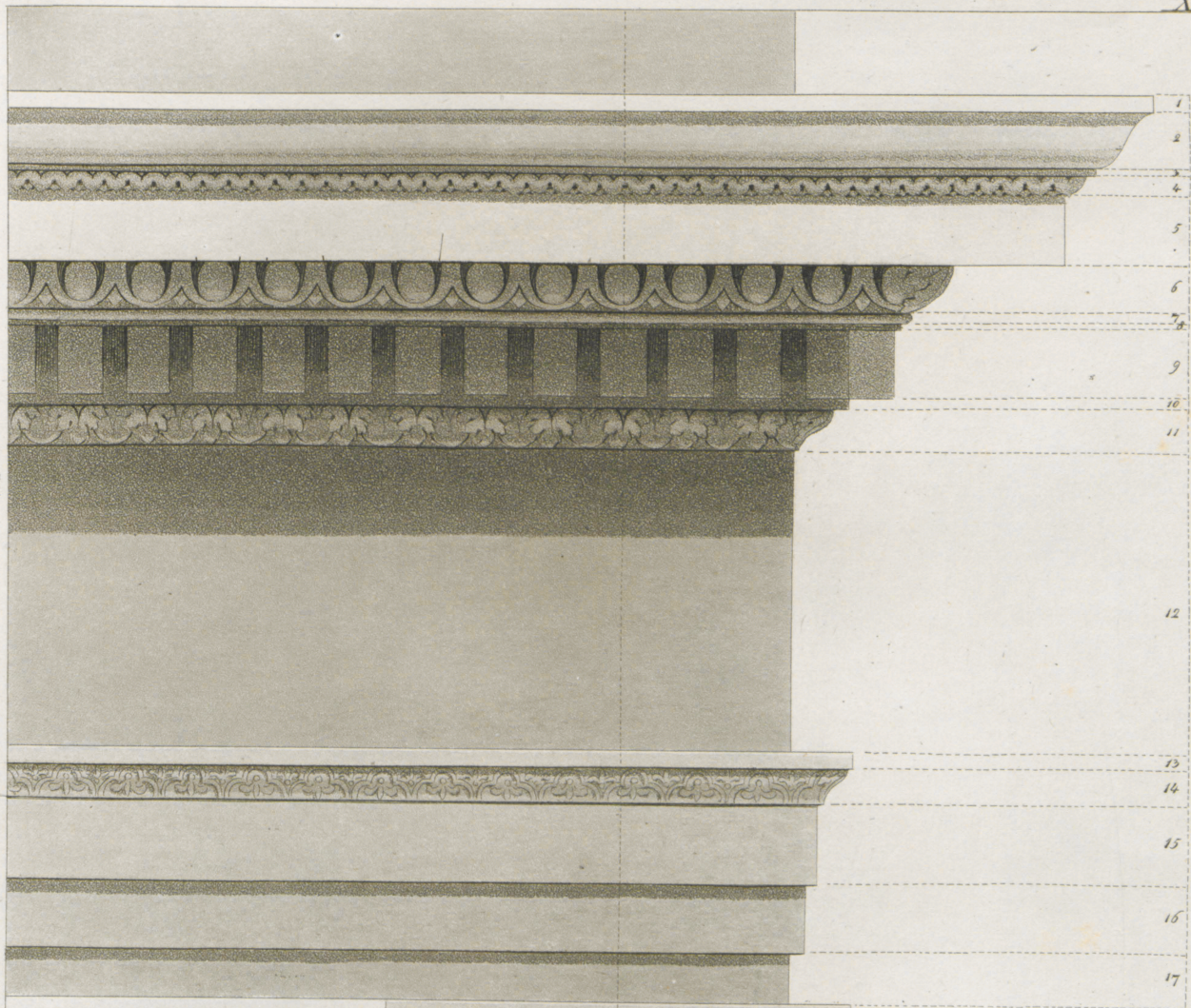

3 6 9 12 Part 1 2 3 4 Model

Fig 88

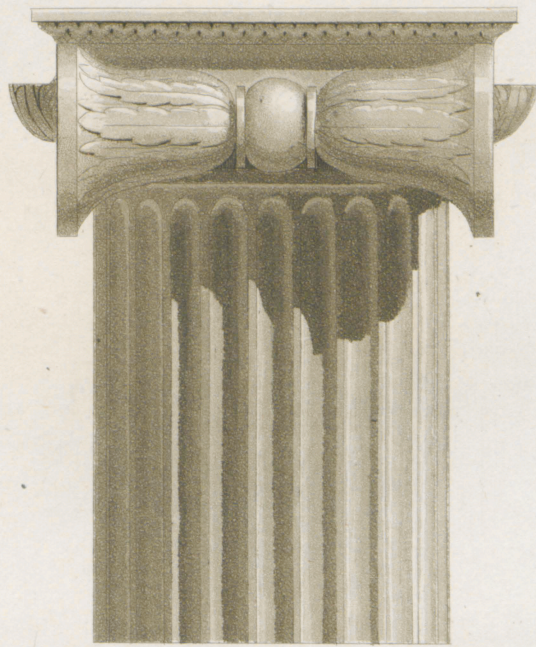

Fig 89

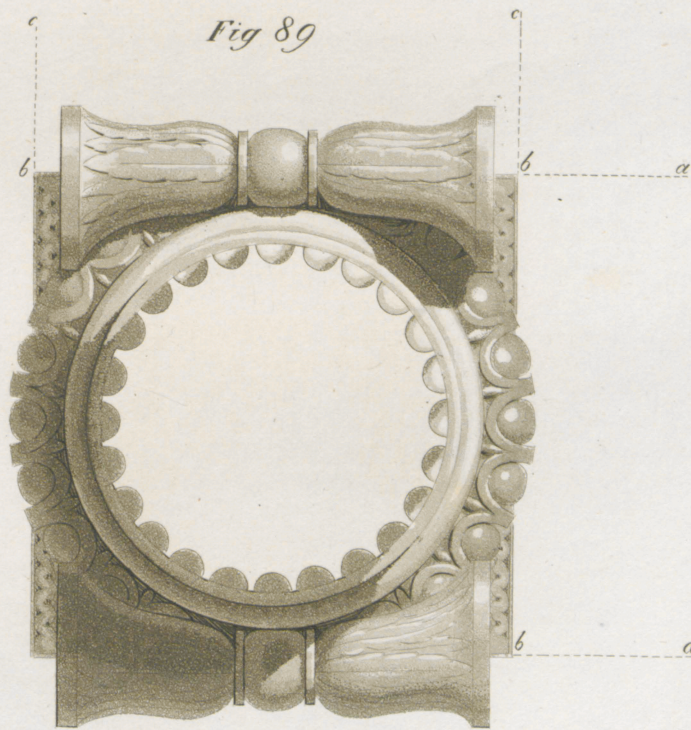

Fig 90



Fig 92

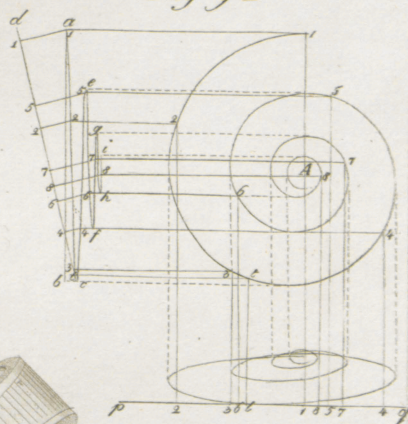
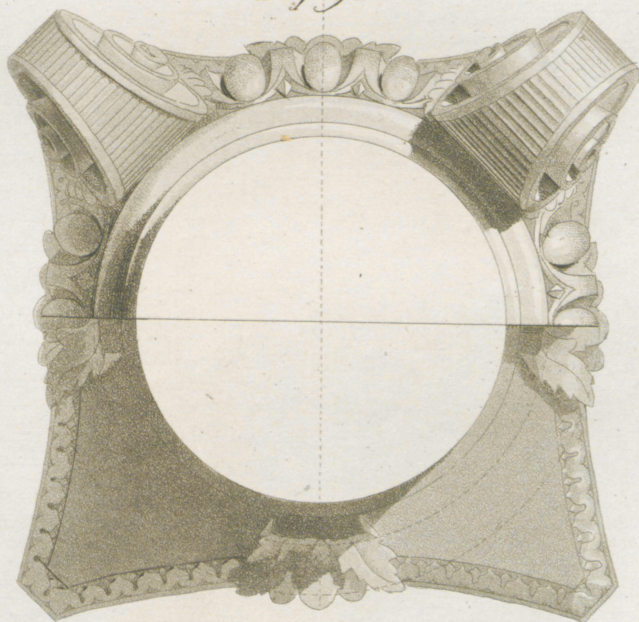
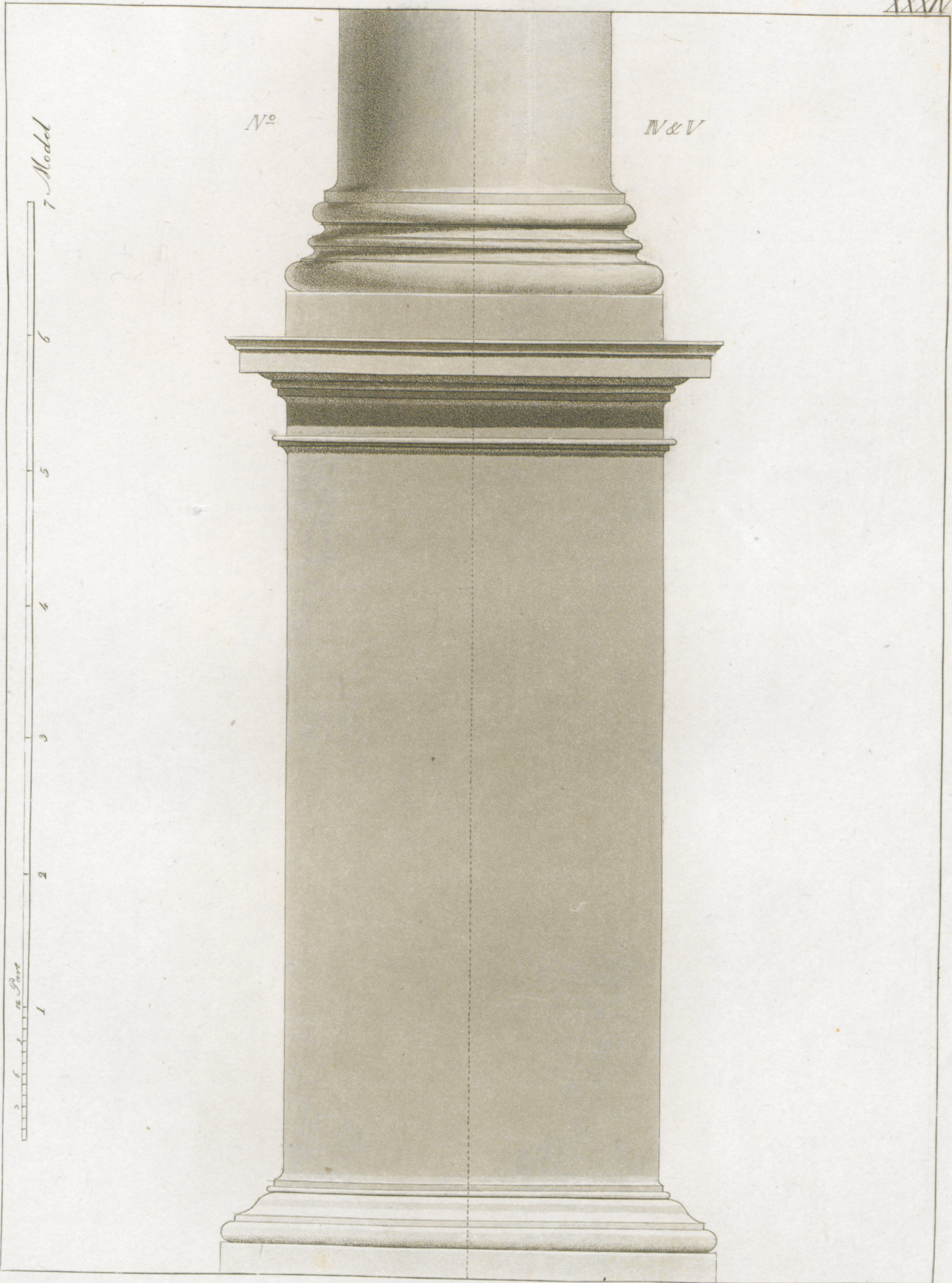

Fig 91



3 6 9 12 Part 1 2 3 Model



N°

N&V

Model

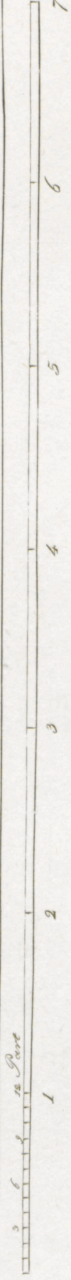

Fig 93

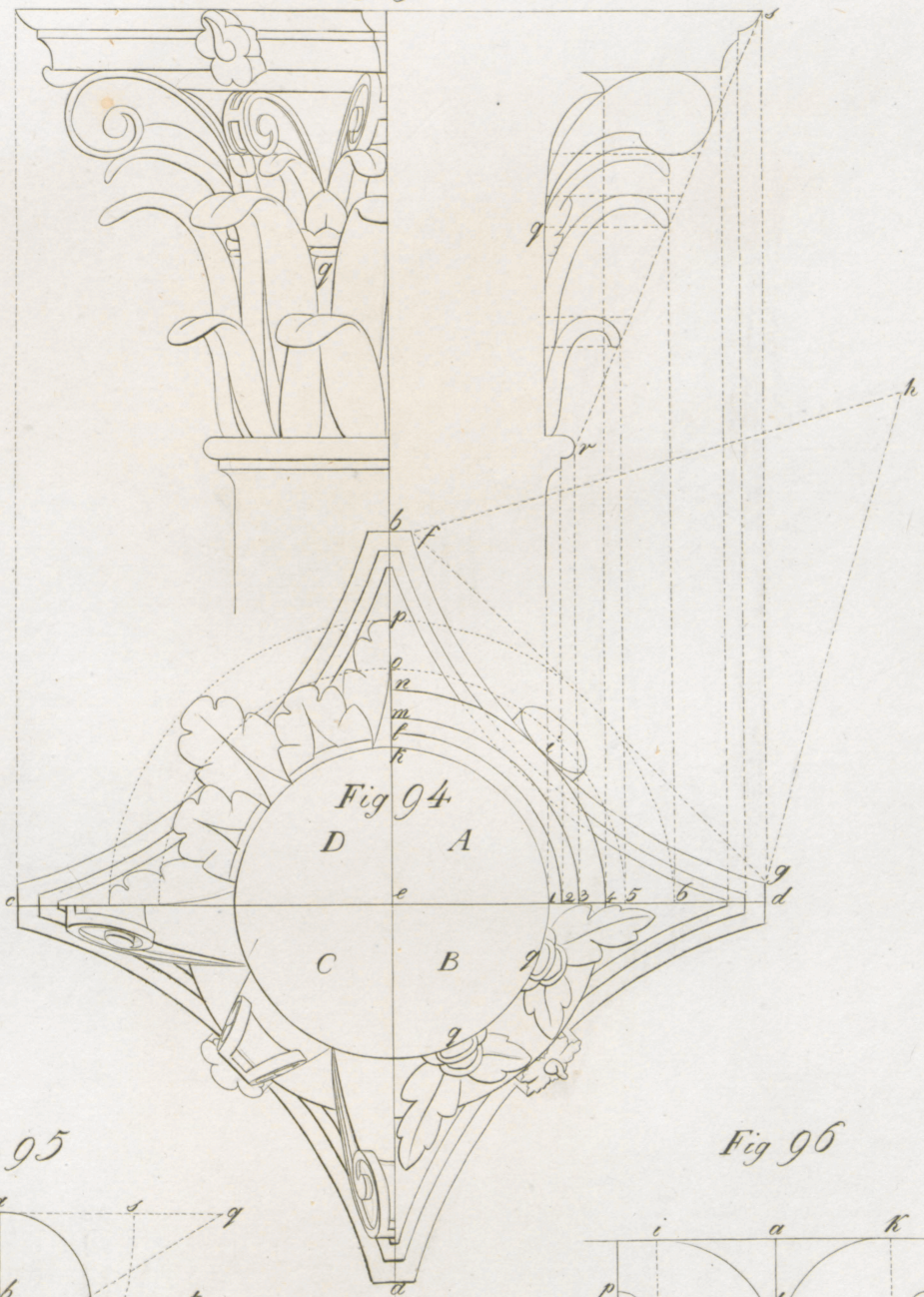

Fig 94

D A
C B

Fig 95

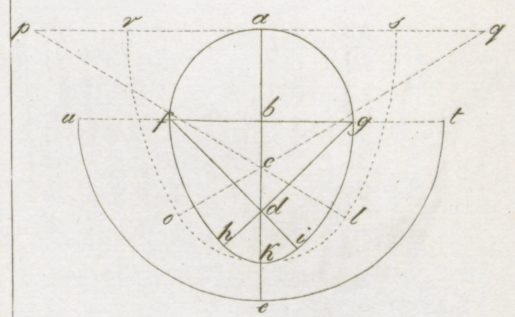
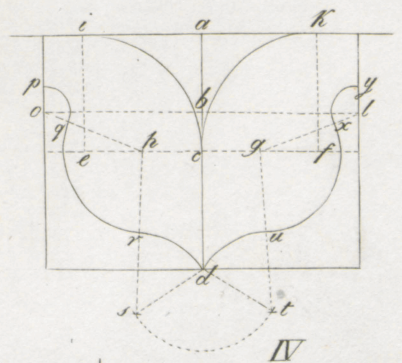

Fig 96



I

II

III

IV





N°

IV

Modell



N^o

1

7 Modell

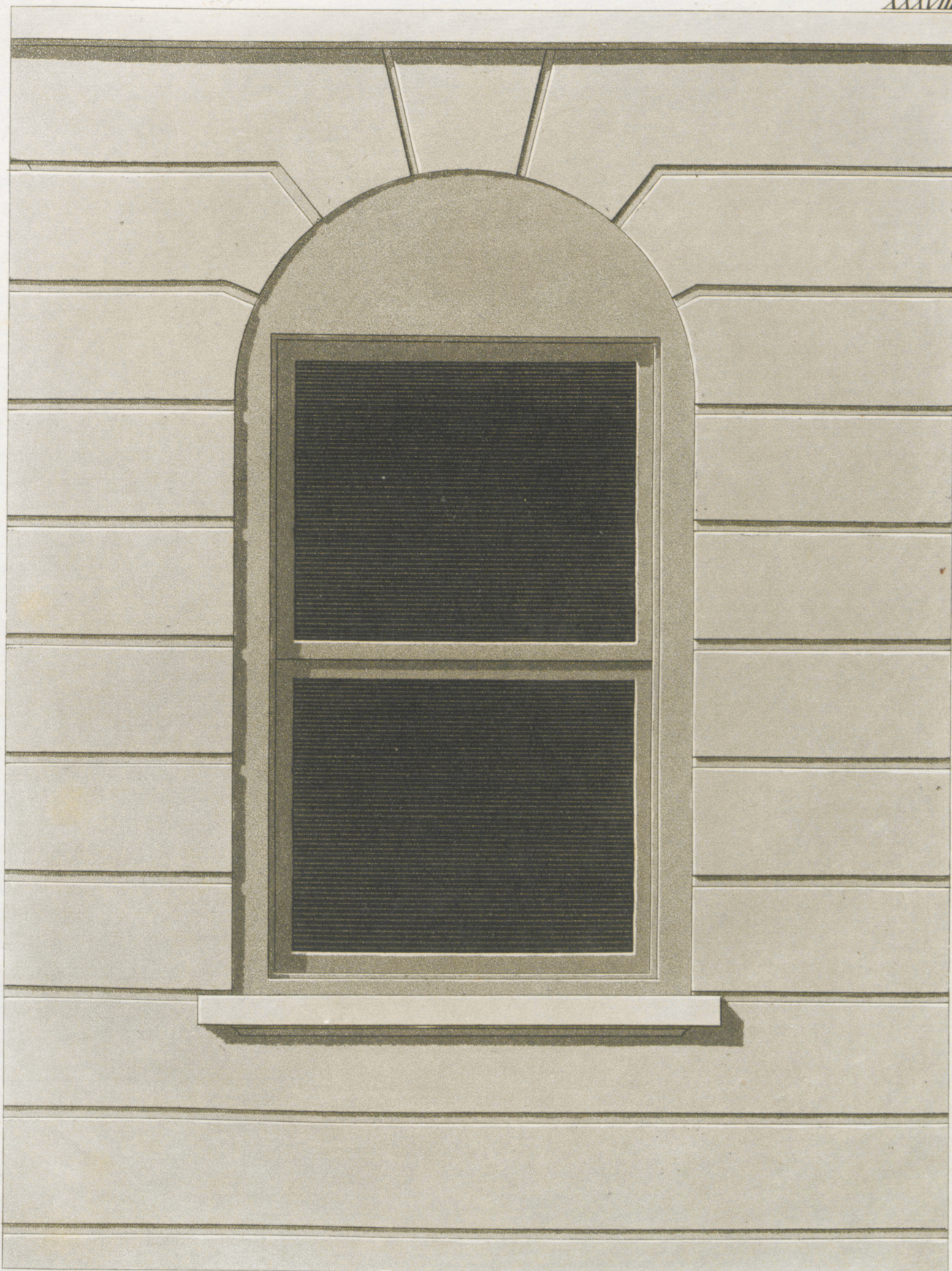



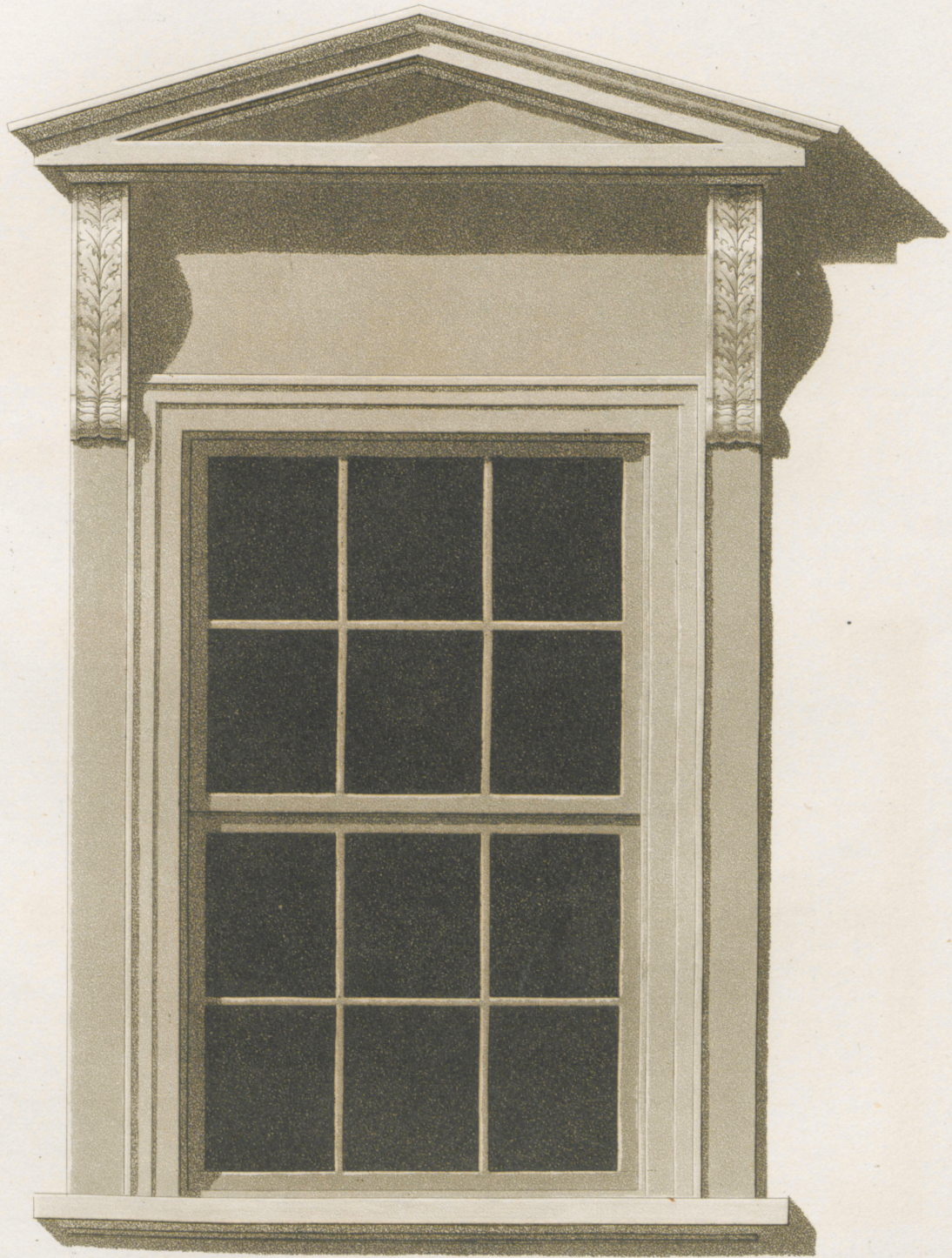

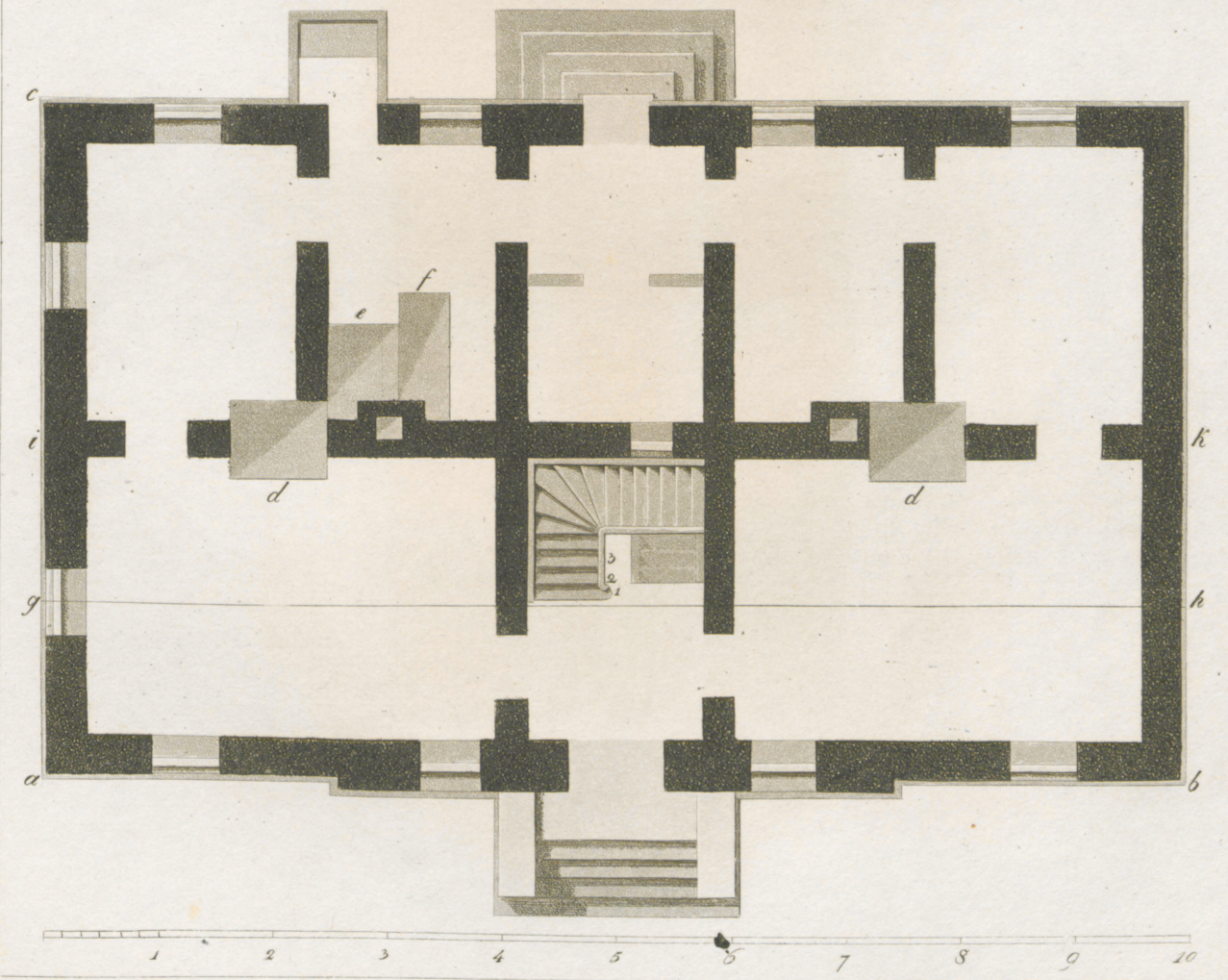
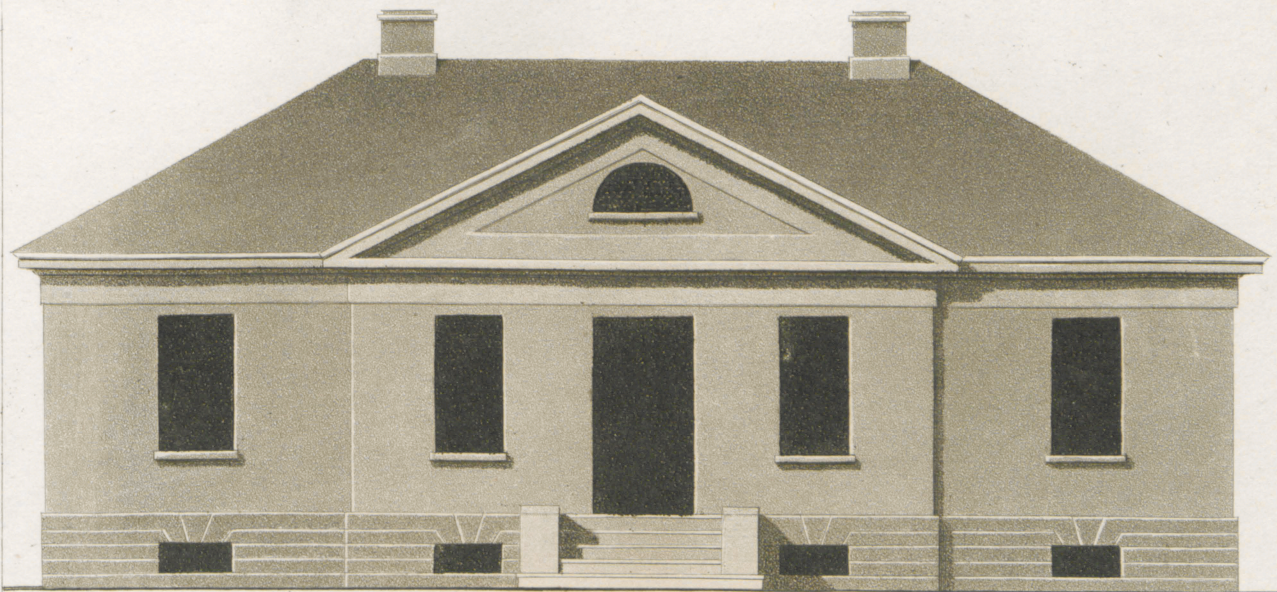

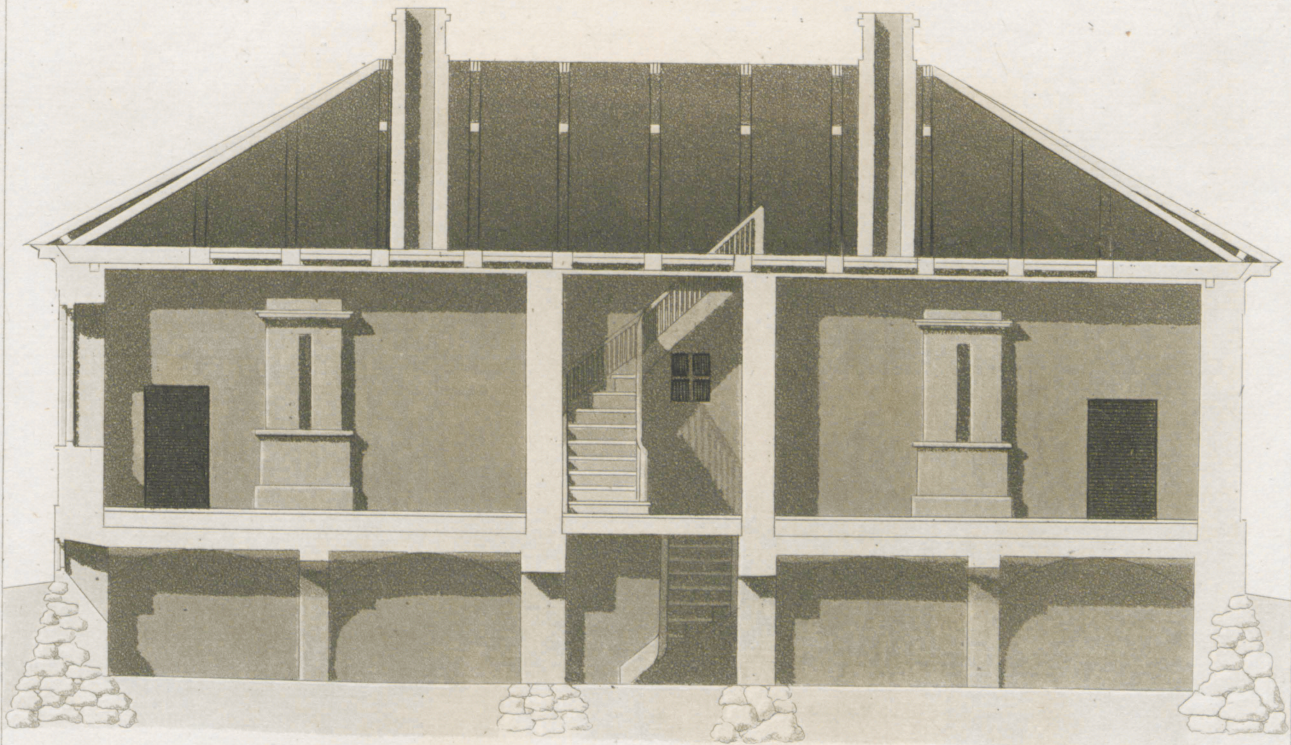
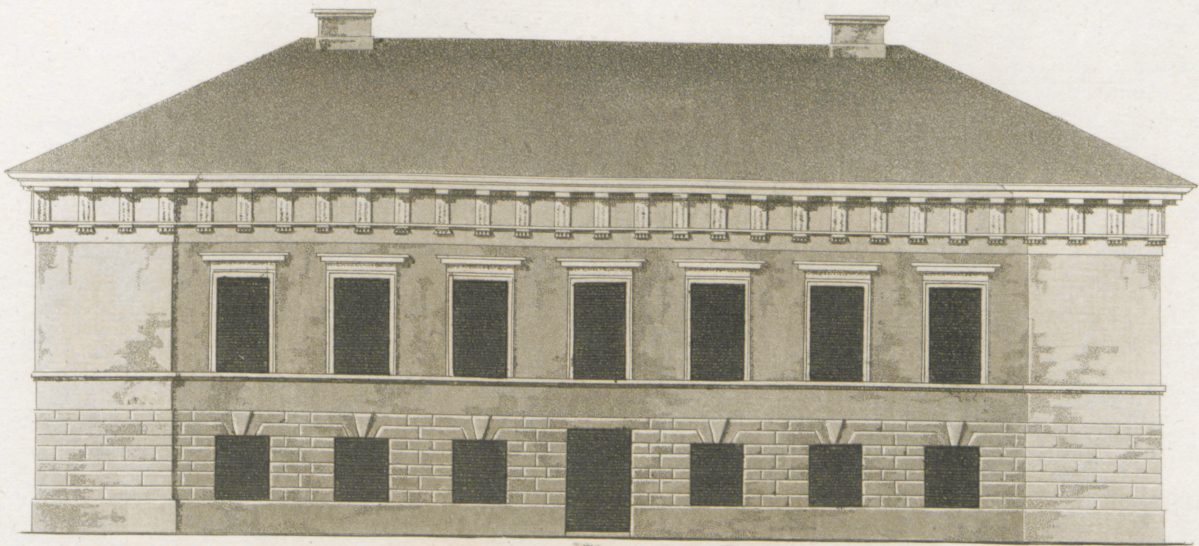

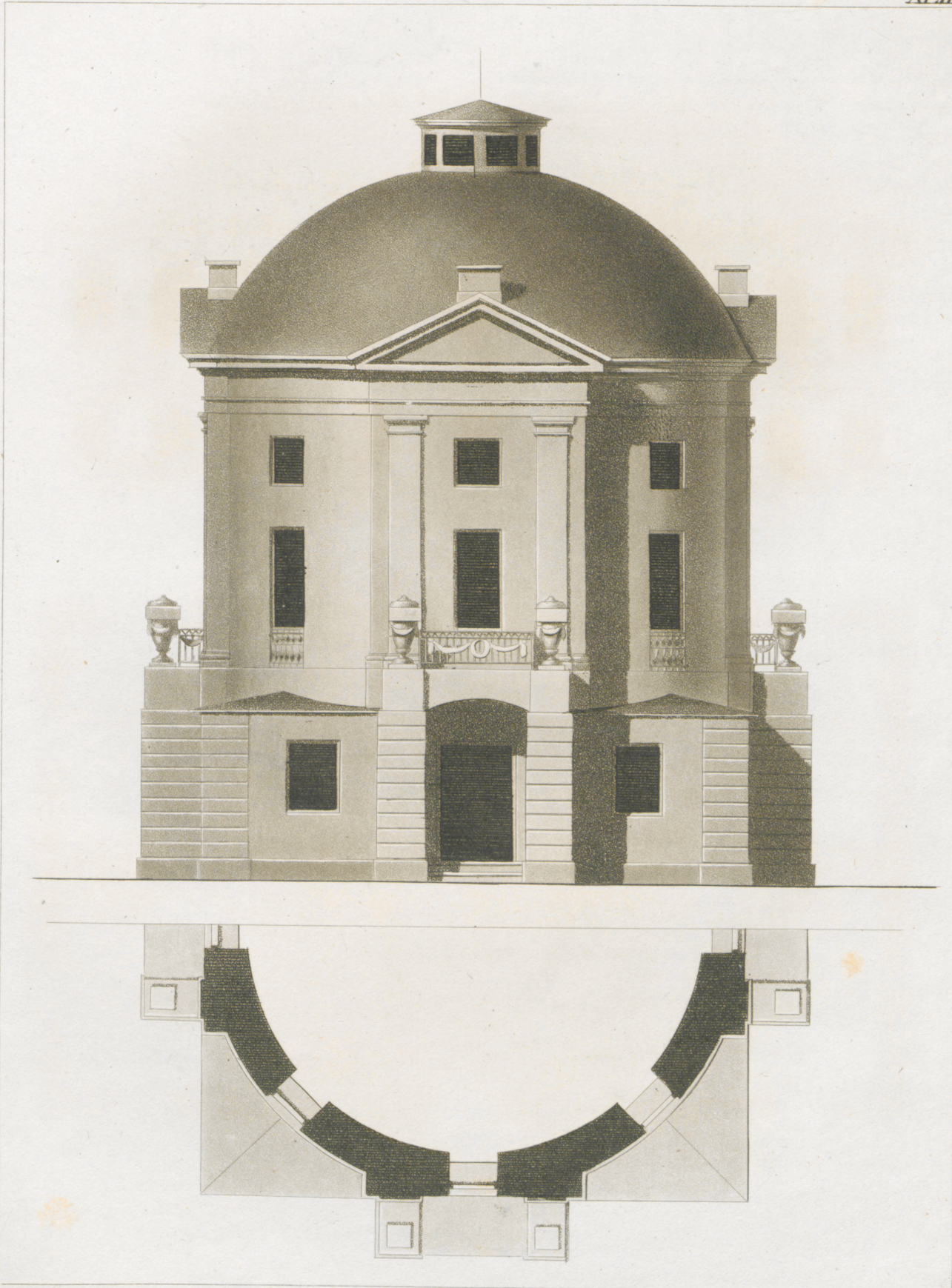

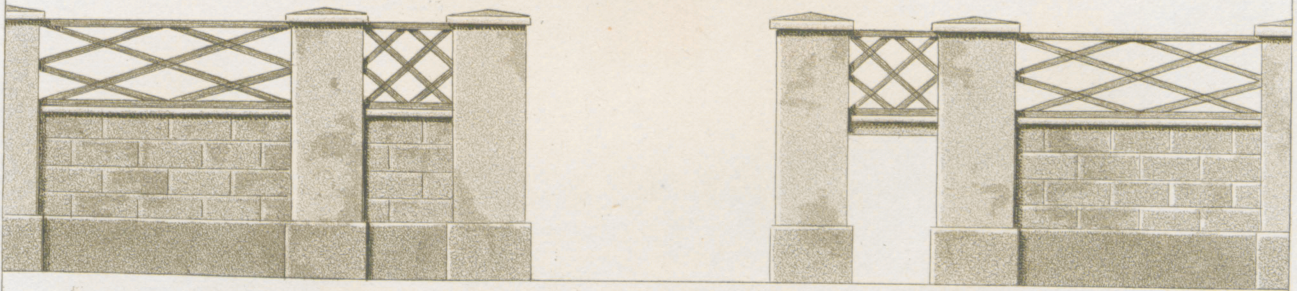

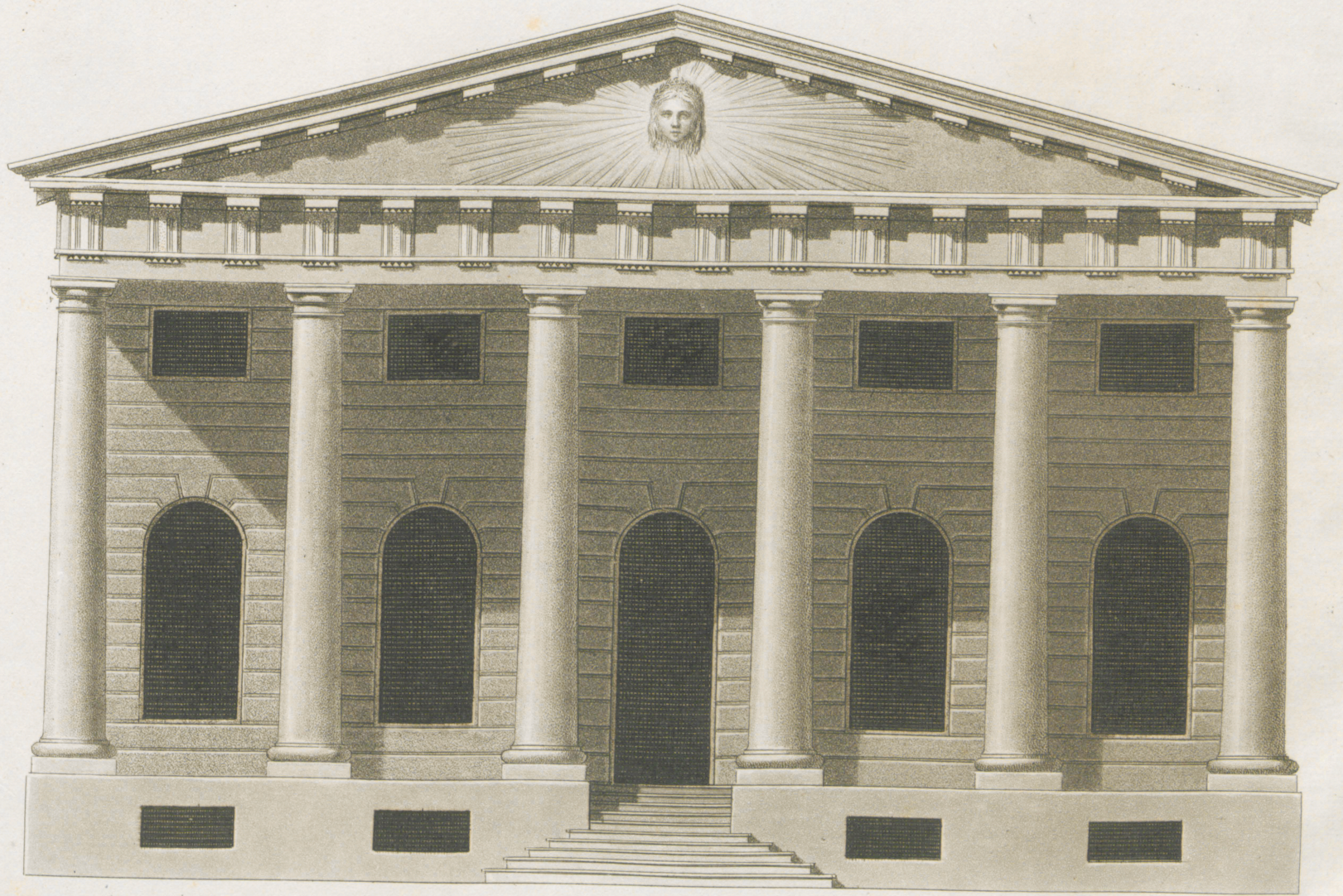



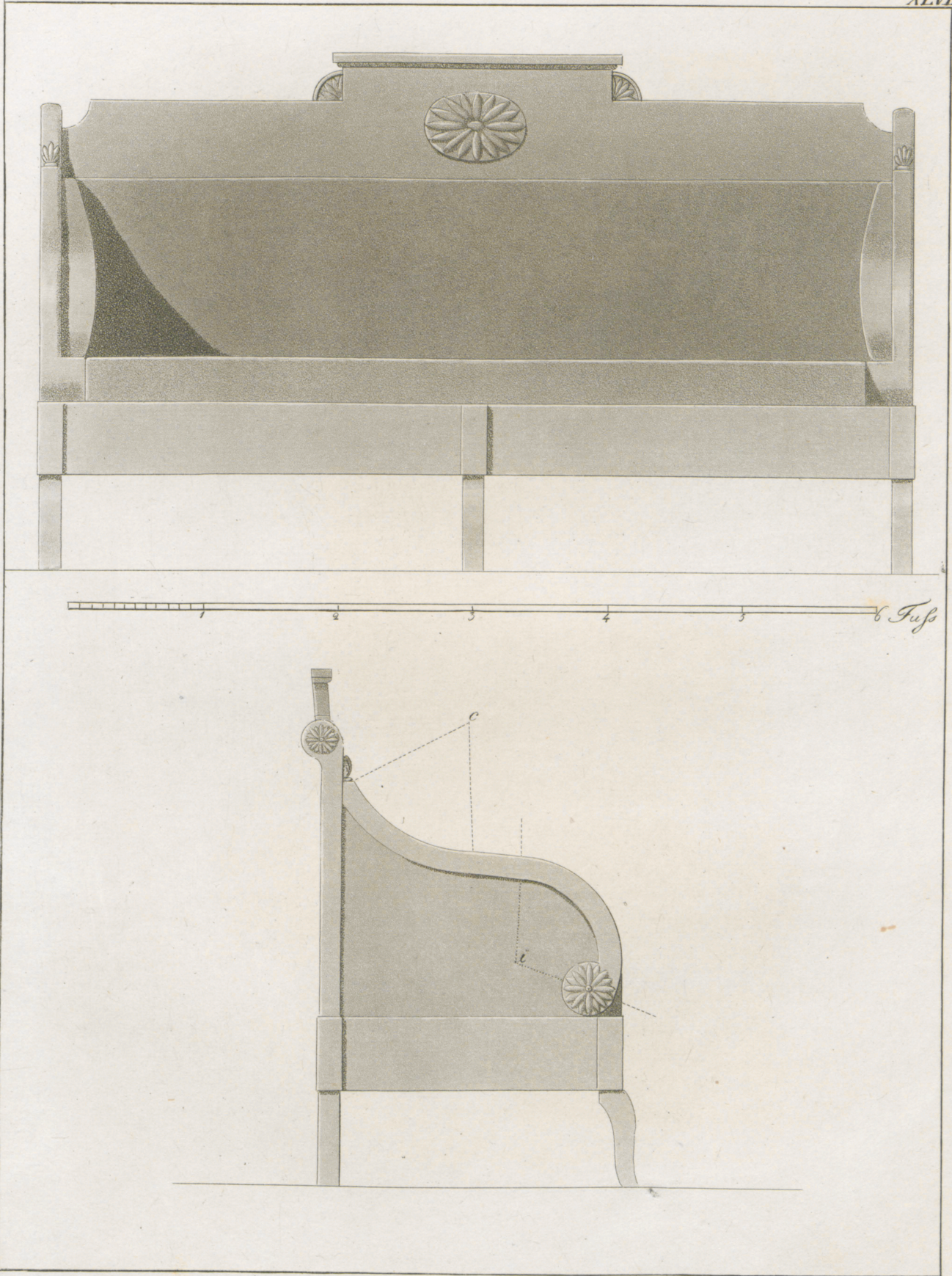

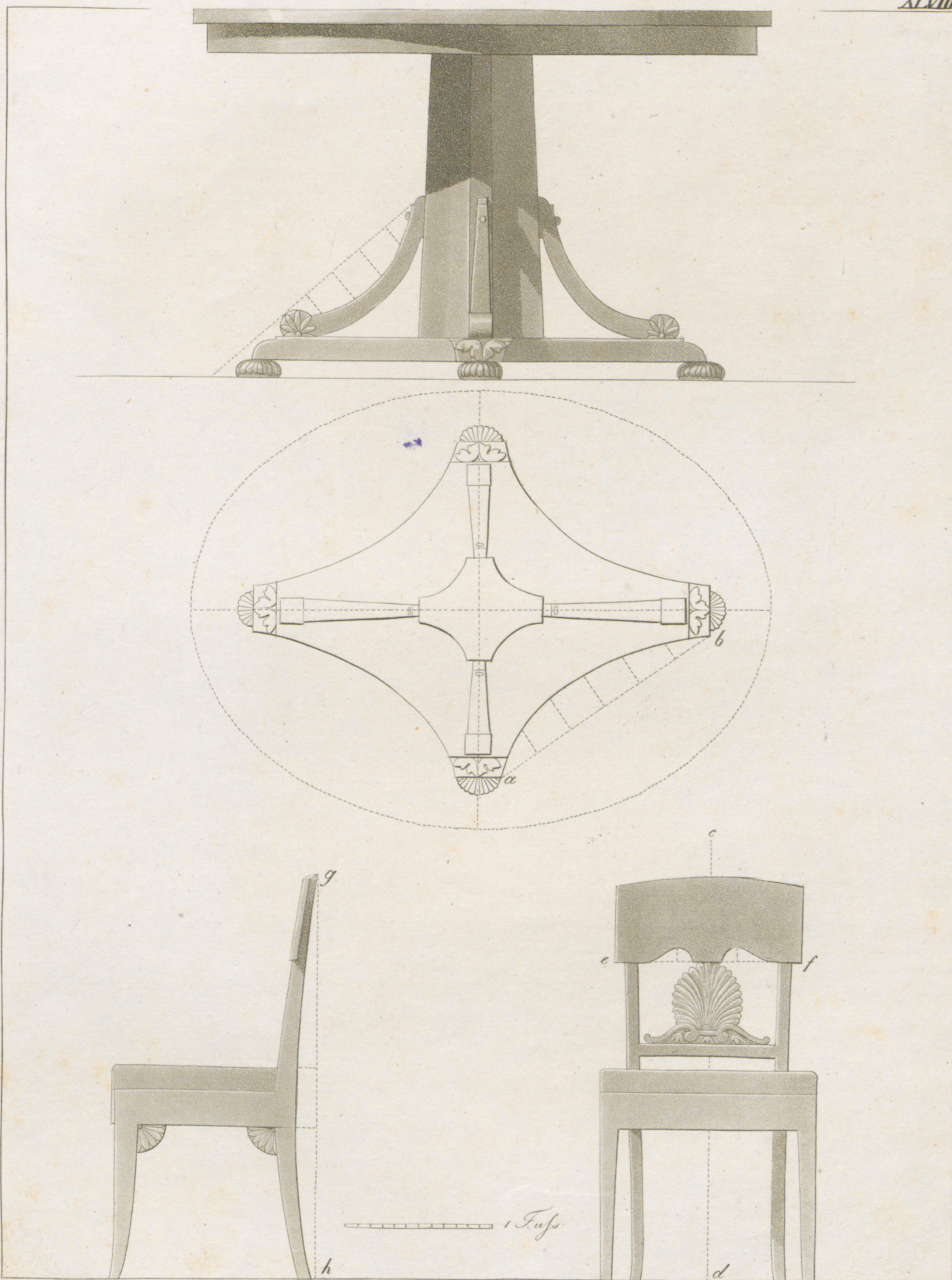

kat B

TRÜ Raamatukogu

415

Fig 97

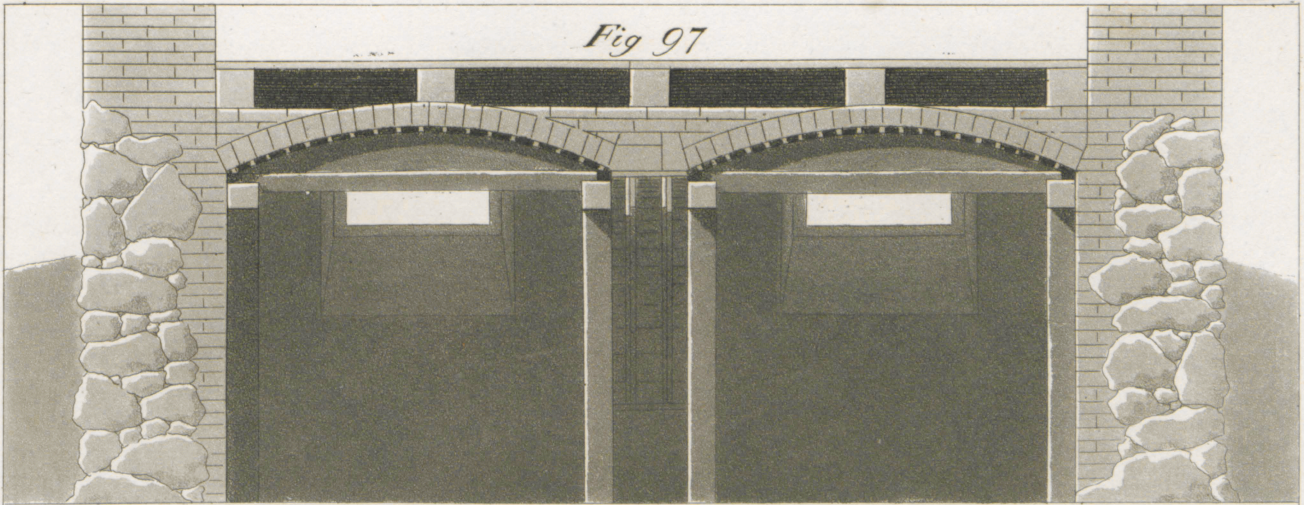

1 2 3 Faden

Fig 98

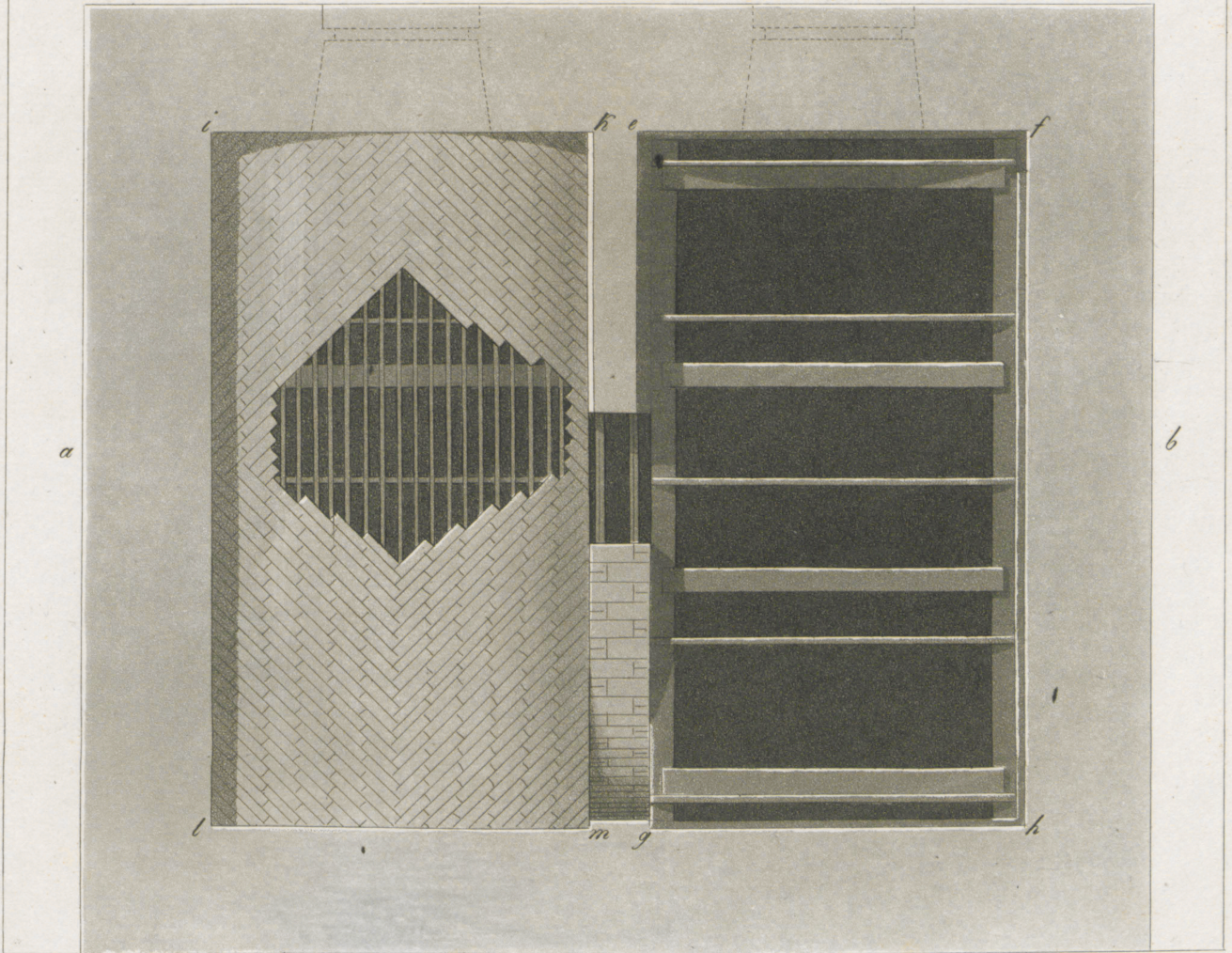

Fig 99

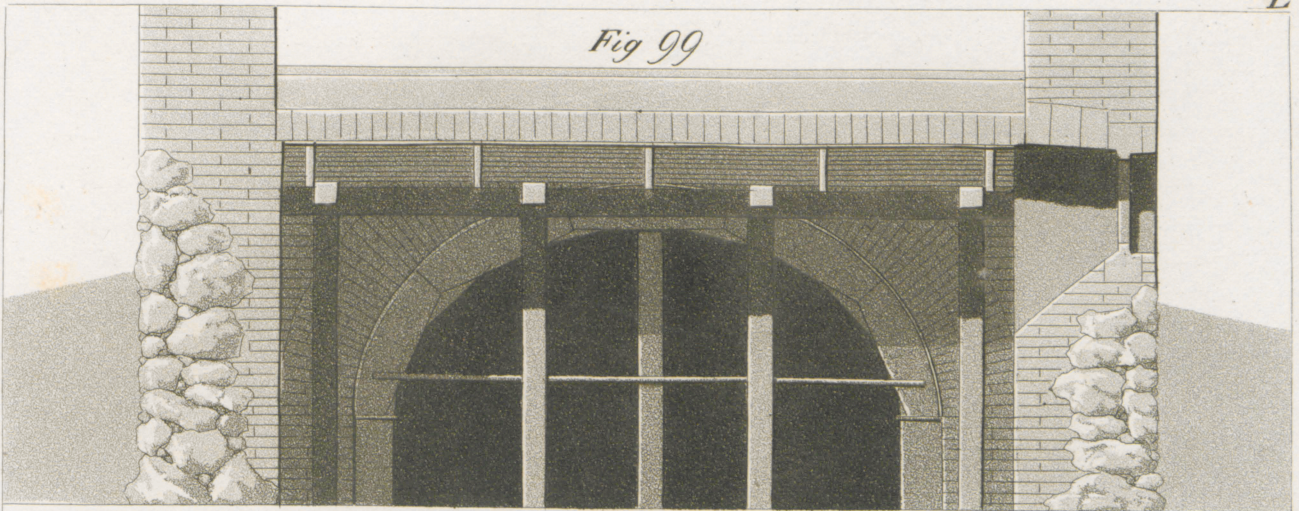

Fig 100

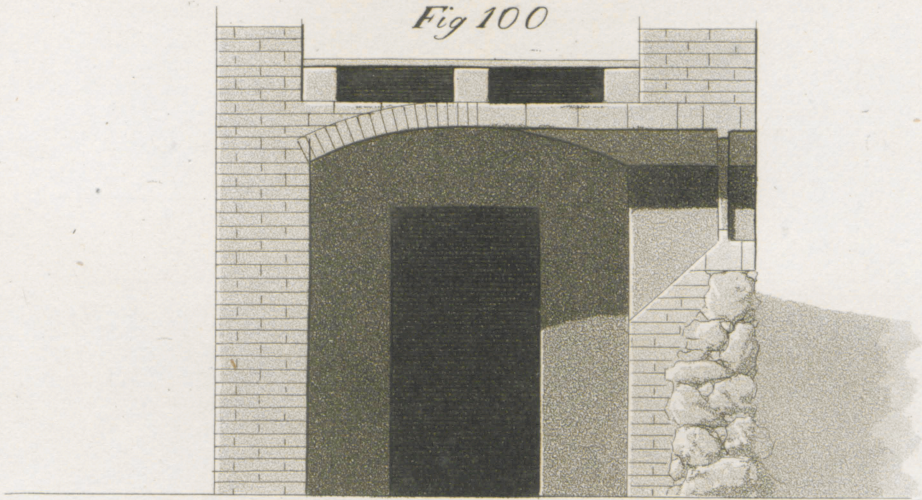

Fig 101

